



# NIMAX

Backward centrifugal fan, for clean or slightly dusty air

Ventilador centrífugo a reacción, para aire limpio o ligeramente polvoriento



## NIMAX vs NIMUS

NIMAX has higher profile turbine height than NIMUS. This helps to achieve better flow rates with the same casing and motor power, achieving greater efficiency.

De perfil, la turbina de NIMAX tiene mayor altura que NIMUS. Esto ayuda a conseguir mejores caudales teniendo la misma caja y potencia de motor, lo que ayuda a conseguir una mayor eficiencia.

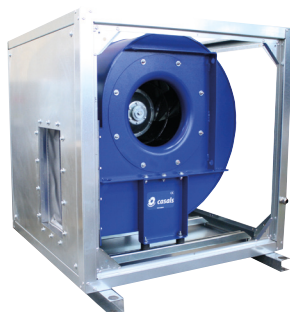

\* Under request / Bajo demanda :  
Nimax + AB (Acoustic box/ caja acústica)

### MANUFACTURING FEATURES

- Medium pressure centrifugal fan with direct coupling.
- Reinforced housing made of carbon laminated steel, protected against corrosion by powder coating polyester resin RAL 5010. Finish C3.
- Casing fully latched and adjustable.
- Self-cleaning turbine and reinforced impeller with high-performance backward (reaction) blades made of carbon laminated steel dynamically balanced to minimize noise and vibrations. Graffiti black RAL 9005.
- The size of the centrifugal impeller and casing is larger than a NIMUS, which increases the performance of the unit.
- Squirrel cage standardized asynchronous IEC motor with IP-55 protection and class F electrical insulation. Standard voltages 230/400V 50Hz for three-phase motors up to 4kW and 400/690V 50Hz, for higher powers.
- Motor (B3) with feet and support base.
- Models from 500 are supplied with a front support foot, for the other models the front support foot is optional.
- Available in the following guidelines (to be indicated in case of order): LG0, LG45, LG90, LG135, LG180; LG225, LG270, LG315, RD0, RD45, RD90, RD135, RD180; RD225, RD270, RD315.
- Maximum continuous working temperature: transported air 130°C, ambient 60°C.

### APPLICATIONS

- Suitable for moving clean or dusty air.
- Designed to be installed in the suction or discharge duct.
- Paint booths.
- Dust collection.
- Dryers of the food industry.
- Food processing.
- Incineration.
- Odour control in industry.
- Indoor / outdoor pollution control.
- Big buildings.
- Malls.
- Factories / Industrial warehouses.
- Warehouses.
- Smoke extraction.
- Boilers and ovens.
- Filtering technology.
- Manufacture and treatment of chemical products.
- Tunnels.
- Underground stations.

### UNDER REQUEST

- Fans for 60Hz or special voltages.
- 2 speed motor.
- C4 or C5 coating painting.
- Hot dip galvanized.
- Inox 304 (normal or electro polished finish).
- Inox 316 (normal or electro polished finish).
- Cooling impeller.
- Anticorrosive painting.
- Fully welded housing (waterproof).
- Inspection door for easy maintenance and cleaning.
- Drainage systems.
- Airtight axle.
- Other brands of motors.
- With heat slingers.
- Non-sparking air passage and standard motor.

### CARACTERÍSTICAS CONSTRUCTIVAS

- Ventilador centrífugo de media presión con acoplamiento directo.
- Carcasa reforzada fabricada en acero laminado al carbono, protegida contra la corrosión mediante recubrimiento de polvo de resina poliéster de color RAL 5010. Acabado C3.
- Carcasa totalmente engatillada y orientable.
- Turbina autolimpiante y rodete reforzado de álabes hacia atrás (a reacción) de alto rendimiento fabricado en acero laminado al carbono equilibrado dinámicamente para minimizar el ruido y las vibraciones. Pintada de color negro RAL 9005.
- El tamaño de la turbina centrífuga y la caja de viento es de mayores dimensiones que un NIMUS, con lo que se consigue incrementar las prestaciones de la máquina.
- Motor IEC asíncrono normalizado de jaula de ardilla con protección IP-55 y aislamiento eléctrico clase F. Voltajes estándar 230/400V 50Hz para motores trifásicos hasta 4kW y 400/690V 50Hz para potencias superiores.
- Motor con patas (B3) soportado sobre pie soporte motor.
- Los modelos de tamaño 500 y superiores se suministran con pie soporte delantero, para el resto de modelos el pie soporte delantero es opcional.
- Disponible en las siguientes orientaciones (a indicar en caso de pedido): LG0, LG45, LG90, LG135, LG180; LG225, LG270, LG315, RD0, RD45, RD90, RD135, RD180; RD225, RD270, RD315.
- Temperatura máxima de trabajo en continuo: aire transportado: 130°C, ambiente: 60°C.















### APLICACIONES

- Adecuados para mover aire limpio o polvoriento.
- Diseñados para instalarse en conducto para la aspiración o la impulsión.
- Cabinas de pintura.
- Recogida de polvo.
- Secadores de la industria alimenticia.
- Procesamiento de alimentos.
- Incineración.
- Control de olores en industria.
- Control de polución interior/externo.
- Grandes edificios.
- Centros comerciales.
- Fábricas / Naves industriales.
- Almacenes.
- Extracción de humos.
- Calderas y hornos.
- Tecnología de filtrado.
- Fabricación y tratamiento de productos químicos.
- Túneles.
- Estaciones subterráneas.

### BAJO DEMANDA

- Ventiladores para 60Hz o voltajes especiales.
- Motor 2 velocidades.
- Acabado pintura C4-C5.
- Galvanizado en caliente.
- Inox 304 (acabado normal o electropulido).
- Inox 316 (acabado normal o electropulido).
- Con rodete de refrigeración.
- Pintura anticorrosiva.
- Carcasa totalmente soldada (estanca).
- Puerta inspección para facilitar el mantenimiento y la limpieza.
- Drenaje.
- Eje estanco.
- Otras marcas de motores.
- Paso de aire antichispas y motor estándar.

### ACCESSORIES / accesorios

 <p><b>INT</b> Interruptor de corte Safety switch</p>	 <p><b>SFC</b> Variador de velocidad frecuencial Frequency speed controller</p>	 <p><b>AVR</b> Amortiguador antivibrátil de caucho Anti-vibration rubber block</p>	 <p><b>AVS</b> Amortiguador de muelles Spring anti-vibration block</p>
 <p><b>RA</b> Rejilla aspiración Inlet protection guard</p>	 <p><b>SIL-C</b> Silenciador circular aspiración/impulsión inlet-outlet circular silencer</p>	 <p><b>RIS</b> Reja impulsión Outlet guard</p>	 <p><b>BIDS</b> Brida antivibratoria rectangular-rectangular Rectangular-rectangular anti-vibration flange</p>
 <p><b>EIS</b> Embocadura impulsión Outlet flange</p>	 <p><b>BADS</b> Brida antivibratoria circular-circular Coupling flange</p>	 <p><b>AC</b> Brida conexión Connection flange</p>	 <p><b>JE 45</b> Junta elástica Flexible joint</p>
 <p><b>BA-400</b> Brida antivibratoria 400°/2h. Anti-vibrating flange 400°/2h. flexible</p>	 <p><b>FS</b> Pie soporte delantero para ventiladores de media y alta presión Front support for medium and high pressure fans</p>	 <p><b>AB</b> Cabinas acústicas para ventiladores centrífugos Casals Acoustic cabins for Casals centrifugal fans</p>	

### THREE PHASE RANGE / serie trifásica

#### 2 POLE / 2 polos

Code *	Model	R.P.M.	Rated I (A) 400 V	Rated Power kW	Air flow m³/h	Sound dB (A)	Weight Kg	Connect. diagram
NX313290	NIMAX 313 T2 1,5kW	2865	3,14	1,50	5.240	60	36,94	1
NX314290	NIMAX 314 T2 1,5kW	2865	3,14	1,50	5.500	60	36,89	1
NX353290	NIMAX 353 T2 2,2kW	2840	4,58	2,20	7.500	63	45,95	1
NX3542100	NIMAX 354 T2 3kW	2880	5,92	3	7.870	64	50,47	1
NX4032112	NIMAX 403 T2 4kW	2880	7,63	4	10.730	67	63,55	1
NX4042132	NIMAX 404 T2 5,5kW	2910	10,6	5,50	11.260	67	75,16	1
NX4532132	NIMAX 453 T2 7,5kW	2910	14,1	7,50	15.280	70	89,90	1
NX4542132	NIMAX 454 T2 11kW	2940	20,8	11	16.040	71	90,43	1
NX5032160	NIMAX 503 T2 15kW	2935	27,4	15	20.960	74	115,15	1
NX5042160	NIMAX 504 T2 15kW	2935	27,4	15	22.000	74	116,85	1

\* This code corresponds to the model | Este código corresponde al modelo LG270

#### 4 POLE / 4 polos

Code *	Model	R.P.M.	Rated I (A) 400 V	Rated Power kW	Air flow m³/h	Sound dB (A)	Weight Kg	Connect. diagram
NX313471	NIMAX 313 T4 0,37kW	1400	1,07	0,37	2.620	45	35,81	1
NX314471	NIMAX 314 T4 0,37kW	1400	1,07	0,37	2.750	45	36,04	1
NX353471	NIMAX 353 T4 0,37kW	1400	1,07	0,37	3.750	48	44,79	1
NX354471	NIMAX 354 T4 0,37kW	1400	1,07	0,37	3.940	49	45,26	1
NX403480	NIMAX 403 T4 0,55kW	1400	1,49	0,55	5.370	52	57,48	1
NX404480	NIMAX 404 T4 0,55kW	1400	1,49	0,55	5.630	52	57,89	1
NX453490	NIMAX 453 T4 1,1kW	1450	2,49	1,10	7.640	55	72,26	1
NX454490	NIMAX 454 T4 1,1kW	1450	2,49	1,10	8.020	56	72,87	1
NX503490	NIMAX 503 T4 1,5kW	1440	3,26	1,50	10.480	59	90,45	1
NX5044100	NIMAX 504 T4 2,2kW	1435	4,64	2,20	11.000	59	97,23	1
NX5634100	NIMAX 563 T4 3kW	1420	6,17	3	14.730	62	125,23	1
NX5644100	NIMAX 564 T4 3kW	1420	6,17	3	15.460	63	126,18	1
NX6334132	NIMAX 633 T4 5,5kW	1460	10,5	5,50	20.970	66	166,71	1
NX6344132	NIMAX 634 T4 5,5kW	1460	10,5	5,50	22.010	66	170,69	1
NX7134132	NIMAX 713 T4 11kW	1455	21,2	11	30.010	69	212,46	1
NX7144160	NIMAX 714 T4 11kW	1455	21,2	11	31.500	70	222,65	1
NX8034180	NIMAX 803 T4 18,5kW	1470	35,6	18,50	42.930	73	277,93	1
NX8044180	NIMAX 804 T4 18,5kW	1470	35,6	18,50	45.060	73	279,93	1
NX9034200	NIMAX 903 T4 30kW	1475	56,3	30	61.130	76	379,05	1
NX9044225	NIMAX 904 T4 37kW	1470	69,2	37	64.160	77	382,71	1
NX10034250	NIMAX 1003 T4 55kW	1475	97,1	55	83.850	80	462,52	1
NX10044250	NIMAX 1004 T4 55kW	1475	97,1	55	88.010	80	464,82	1

\* This code corresponds to the model | Este código corresponde al modelo LG270



**6 POLE / 6 polos**

Code	Model	R.P.M.	Rated I (A) 400 V	Rated Power kW	Air flow m³/h	Sound dB (A)	Weight Kg	Connect. diagram
NX503680	NIMAX 503 T6 0,55kW	900	1,8	0,55	6.990	50	89,92	1
NX504680	NIMAX 504 T6 0,55kW	900	1,8	0,55	7.330	50	90,72	1
NX563690	NIMAX 563 T6 1,1kW	925	2,78	1,10	9.820	53	118,71	1
NX564690	NIMAX 564 T6 1,1kW	925	2,78	1,10	10.300	54	119,71	1
NX6336100	NIMAX 633 T6 1,5kW	940	3,71	1,50	13.980	57	154,50	1
NX6346112	NIMAX 634 T6 2,2kW	965	5,94	2,20	14.670	57	156,23	1
NX7136132	NIMAX 713 T6 3kW	960	7,3	3	20.010	60	208,16	1
NX7146132	NIMAX 714 T6 3kW	960	7,3	3	21.000	61	209,71	1
NX8036132	NIMAX 803 T6 5,5kW	960	12,8	5,50	28.620	64	260,36	1
NX8046132	NIMAX 804 T6 5,5kW	960	12,8	5,50	30.040	65	262,16	1
NX9036160	NIMAX 903 T6 11kW	975	-	11	40.750	68	339,60	1
NX9046160	NIMAX 904 T6 11kW	965	22,6	11	42.770	68	342,35	1
NX10036180	NIMAX 1003 T6 15kW	970	27,7	15	55.900	71	411,83	1
NX10046200	NIMAX 1004 T6 18,5kW	975	35,7	18,50	58.670	71	450,85	1

\*This code corresponds to the model | Este código corresponde al modelo LG270

**DIMENSIONS / dimensiones**

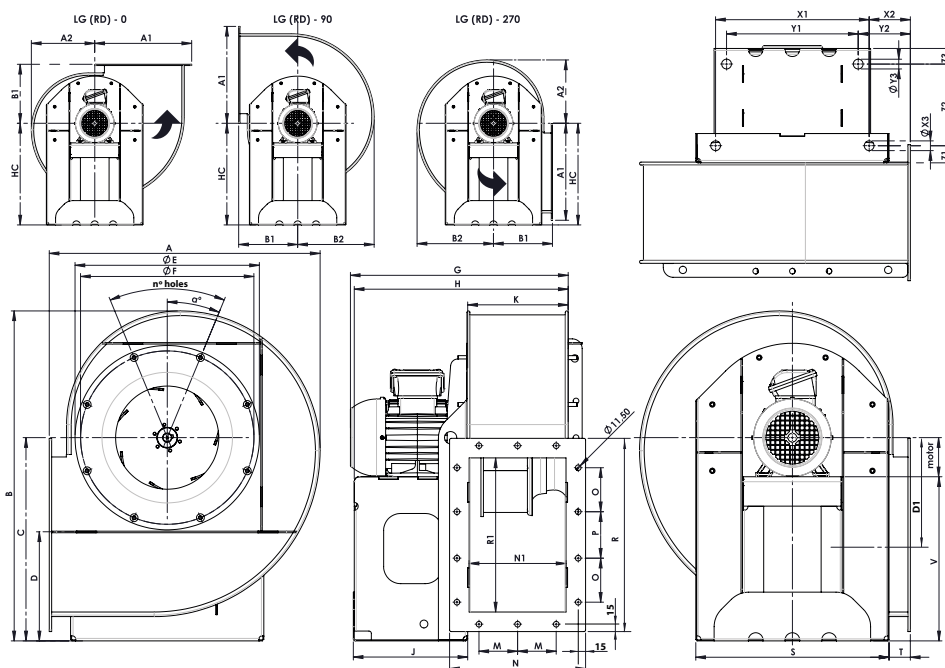

MODEL	A	A1	A2	B	B1	B2	C	D	D1	E	F	G (aprox)	H	HC	J	K	M	N
NIMAX 313 T2 1,5kW	554	396,5	259,2	675	241,3	312,6	415,5	216,5	199	377	354,5	508,4	490,5	415,5	264	228,5	90,5	301
NIMAX 313 T4 0,37kW	554	396,5	259,2	675	241,3	312,6	415,5	216,5	199	377	354,5	457,4	445,5	415,5	219	228,5	90,5	301
NIMAX 314 T2 1,5kW	554	396,5	259,2	675	241,3	312,6	415,5	216,5	199	377	354,5	508,4	490,5	415,5	264	228,5	90,5	301
NIMAX 314 T4 0,37kW	554	396,5	259,2	675	241,3	312,6	415,5	216,5	199	377	354,5	457,4	445,5	415,5	219	228,5	90,5	301
NIMAX 353 T2 2,2kW	617	441,8	290,9	751,5	266,2	351,1	460,5	236	224	419	394,5	543	519,5	460,5	264	257,5	105	330
NIMAX 353 T4 0,37kW	617	441,8	290,9	751,5	266,2	351,1	460,5	236	224	419	394,5	482	474,5	460,5	219	257,5	105	330
NIMAX 354 T2 3kW	617	441,8	290,9	751,5	266,2	351,1	460,5	236	224	419	394,5	577,1	579,9	460,5	324,5	257,5	105	330
NIMAX 354 T4 0,37kW	617	441,8	290,9	751,5	266,2	351,1	460,5	236	224	419	394,5	482	474,5	460,5	219	257,5	105	330
NIMAX 403 T2 4kW	689	493	326,7	837	294,3	394,6	510,5	257,5	253	464	438	637	615,5	510,5	329	288,5	120,6	361
NIMAX 403 T4 0,55kW	689	493	326,7	837	294,3	394,6	510,5	257,5	253	464	438	530	520,5	510,5	234	288,5	120,6	361
NIMAX 404 T2 5,5kW	689	493	326,7	837	294,3	394,6	510,5	257,5	253	464	438	721,5	680	510,5	393,4	288,5	120,6	361
NIMAX 404 T4 0,55kW	689	493	326,7	837	294,3	394,6	510,5	257,5	253	464	438	530	520,5	510,5	234	288,5	120,6	361
NIMAX 453 T2 7,5kW	768	549,3	366,2	937	325,4	442,5	570,5	286	284	523	485	733,5	715	570,5	393,5	323,5	128	396
NIMAX 453 T4 1,1kW	768	549,3	366,2	937	325,4	442,5	570,5	286	284	523	485	608,5	585,5	570,5	264	323,5	128	396
NIMAX 454 T4 1,1kW	768	549,3	366,2	937	325,4	442,5	570,5	286	284	523	485	608,5	585,5	570,5	264	323,5	128	396

# CENTRIFUGAL MEDIUM PRESSURE FANS / DIRECT

## Ventiladores centrífugos de media presión / directos



MODEL	A	A1	A2	B	B1	B2	C	D	D1	E	F	G (aprox)	H	HC	J	K	M	N
NIMAX 353 T2 2,2kW	617	441,8	290,9	751,5	266,2	351,1	460,5	236	224	419	394,5	543	519,5	460,5	264	257,5	105	330
NIMAX 353 T4 0,37kW	617	441,8	290,9	751,5	266,2	351,1	460,5	236	224	419	394,5	482	474,5	460,5	219	257,5	105	330
NIMAX 354 T2 3kW	617	441,8	290,9	751,5	266,2	351,1	460,5	236	224	419	394,5	577,1	579,9	460,5	324,5	257,5	105	330
NIMAX 354 T4 0,37kW	617	441,8	290,9	751,5	266,2	351,1	460,5	236	224	419	394,5	482	474,5	460,5	219	257,5	105	330
NIMAX 403 T2 4kW	689	493	326,7	837	294,3	394,6	510,5	257,5	253	464	438	637	615,5	510,5	329	288,5	120,6	361
NIMAX 403 T4 0,55kW	689	493	326,7	837	294,3	394,6	510,5	257,5	253	464	438	530	520,5	510,5	234	288,5	120,6	361
NIMAX 404 T2 5,5kW	689	493	326,7	837	294,3	394,6	510,5	257,5	253	464	438	721,5	680	510,5	393,4	288,5	120,6	361
NIMAX 404 T4 0,55kW	689	493	326,7	837	294,3	394,6	510,5	257,5	253	464	438	530	520,5	510,5	234	288,5	120,6	361
NIMAX 453 T2 7,5kW	768	549,3	366,2	937	325,4	442,5	570,5	286	284	523	485	733,5	715	570,5	393,5	323,5	128	396
NIMAX 453 T4 1,1kW	768	549,3	366,2	937	325,4	442,5	570,5	286	284	523	485	608,5	585,5	570,5	264	323,5	128	396
NIMAX 454 T4 1,1kW	768	549,3	366,2	937	325,4	442,5	570,5	286	284	523	485	608,5	585,5	570,5	264	323,5	128	396

MODEL	N1	O	P	R	R1	S	T	V	X1	X2	X3	Y1	Y2	Y3	Z1	Z2	Z3	a°	motor	n°holes
NIMAX 313 T2 1,5kW	221	90	95	395	315	395	43,5	325,5	314	84,3	20	269,2	106,7	20	35	152	32	22,5°	90	8x45°
NIMAX 313 T4 0,37kW	221	90	95	395	315	395	43,5	344,5	314	84,3	20	269,2	106,7	20	35	152	32	22,5°	71	8x45°
NIMAX 314 T2 1,5kW	221	90	95	395	315	395	43,5	325,5	314	84,3	20	269,2	106,7	20	35	152	32	22,5°	90	8x45°
NIMAX 314 T4 0,37kW	221	90	95	395	315	395	43,5	344,5	314	84,3	20	269,2	106,7	20	35	152	32	22,5°	71	8x45°
NIMAX 353 T2 2,2kW	250	105	105	435	355	438	47	370,5	357	87,7	20	269,2	131,6	20	35	197	32	22,5°	90	8x45°
NIMAX 353 T4 0,37kW	250	105	105	435	355	438	47	389,5	357	87,7	20	269,2	131,6	20	35	152	32	22,5°	71	8x45°
NIMAX 354 T2 3kW	250	105	105	435	355	438	47	360,5	357	87,7	20	339,8	96,3	20	35	257	32	22,5°	100	8x45°
NIMAX 354 T4 0,37kW	250	105	105	435	355	438	47	389,5	357	87,7	20	269,2	131,6	20	35	152	32	22,5°	71	8x45°
NIMAX 403 T2 4kW	281	120	120	480	400	487	50,5	398,5	406	91,3	20	339,8	124,4	20	35	262	32	22,5°	112	8x45°
NIMAX 403 T4 0,55kW	281	120	120	480	400	487	50,5	430,5	406	91,3	20	269,2	159,7	20	35	167	32	22,5°	80	8x45°
NIMAX 404 T2 5,5kW	281	120	120	480	400	487	50,5	378,5	406	91,3	20	369,8	109,4	20	35	327	32	22,5°	132	8x45°
NIMAX 404 T4 0,55kW	281	120	120	480	400	487	50,5	430,5	406	91,3	20	269,2	159,7	20	35	167	32	22,5°	80	8x45°
NIMAX 453 T2 7,5kW	316	130	130	530	450	545	53	438,5	464	93,4	20	369,8	140,5	20	35	327	32	22,5°	132	8x45°
NIMAX 453 T4 1,1kW	316	130	130	530	450	545	53	480,5	464	93,4	20	269,2	190,8	20	35	197	32	22,5°	90	8x45°
NIMAX 454 T4 1,1kW	316	130	130	530	450	545	53	480,5	464	93,4	20	269,2	190,8	20	35	197	32	22,5°	90	8x45°

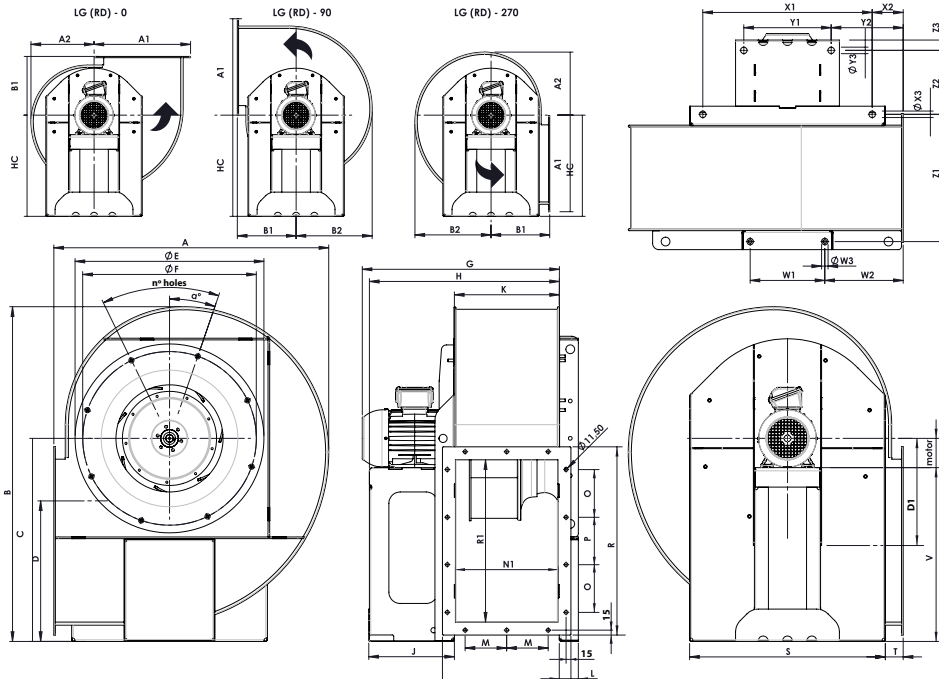

MODEL	A	A1	A2	B	B1	B2	C	D	D1	E	F	G apr.	H	HC	J	K	L	M	N
NIMAX 503 T2 15kW	847,3	606	406	1031,52	356,6	490,7	625,62	309,6	316	582	535	906	854,5	625,5	494	359,5	59	146	432
NIMAX 503 T4 1,5kW	847,3	606	406	1031,52	356,6	490,7	625,62	309,6	316	582	535	643,5	621,5	625,5	264	359,5	59	146	432
NIMAX 503 T6 0,55kW	847,3	606	406	1031,52	356,6	490,7	625,62	309,6	316	582	535	595,5	591,5	625,5	234	359,5	59	146	432
NIMAX 504 T2 15kW	847,3	606	406	1031,52	356,6	490,7	625,62	309,6	316	582	535	906	854,5	625,5	494	359,5	59	146	432
NIMAX 504 T4 2,2kW	847,3	606	406	1031,52	356,6	490,7	625,62	309,6	316	582	535	691,5	682	625,5	324,5	359,5	59	146	432
NIMAX 504 T6 0,55kW	847,3	606	406	1031,52	356,6	490,7	625,62	309,6	316	582	535	595,5	591,5	625,5	234	359,5	59	146	432
NIMAX 563 T4 3kW	942,5	674	453,5	1148,6	394	548,5	695,1	341,1	354	650	608	733,5	725	694,1	326,4	401,5	59	167	474





**CONNECTION DIAGRAMS / esquema de conexiones**

**1 THREE PHASE MOTORS 1 SPEED / motores trifásicos 1 velocidad**

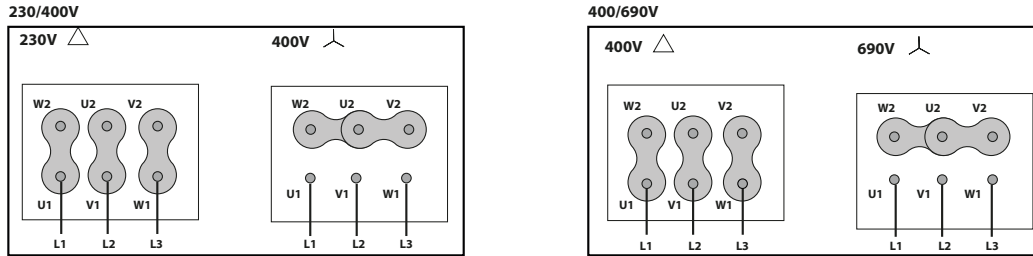

**CHARACTERISTIC CURVES / curvas características**

**2 POLE / 2 polos**

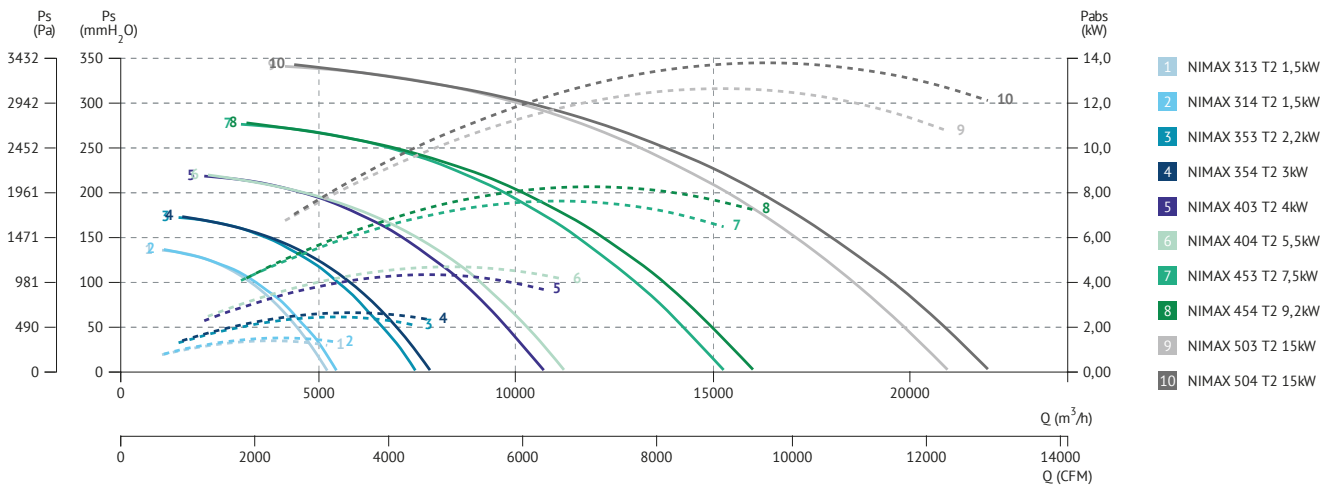

**4 POLE / 4 polos**

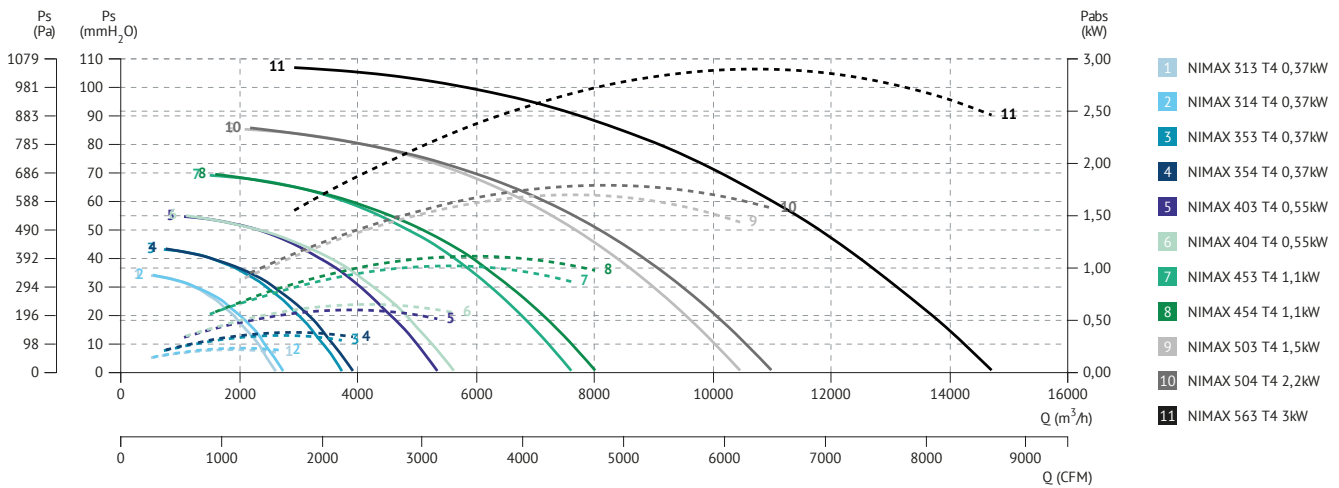



**4 POLE / 4 polos**

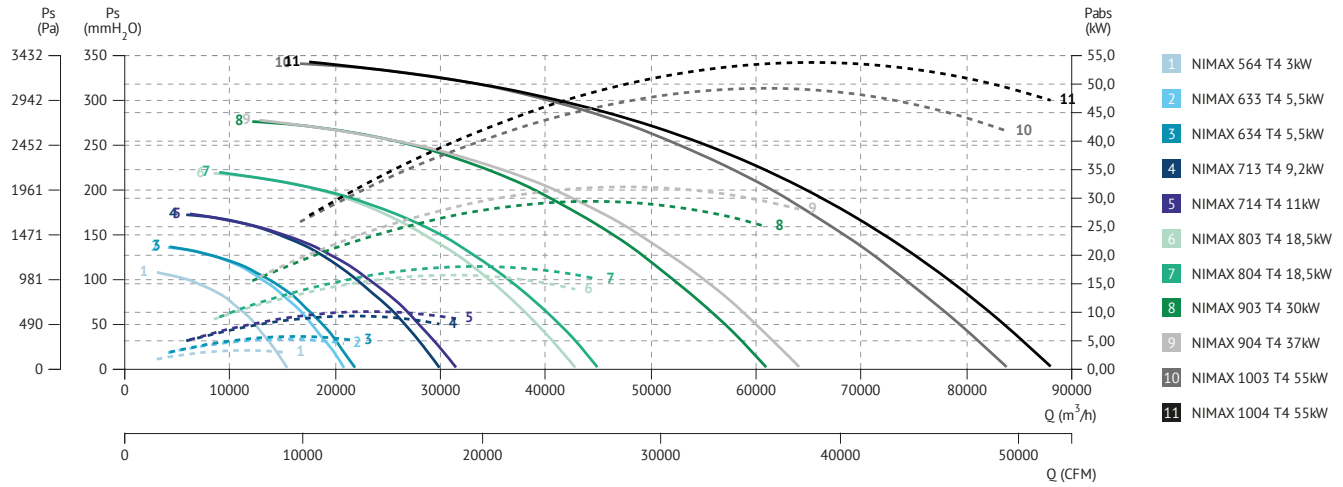

**6 POLE / 6 polos**

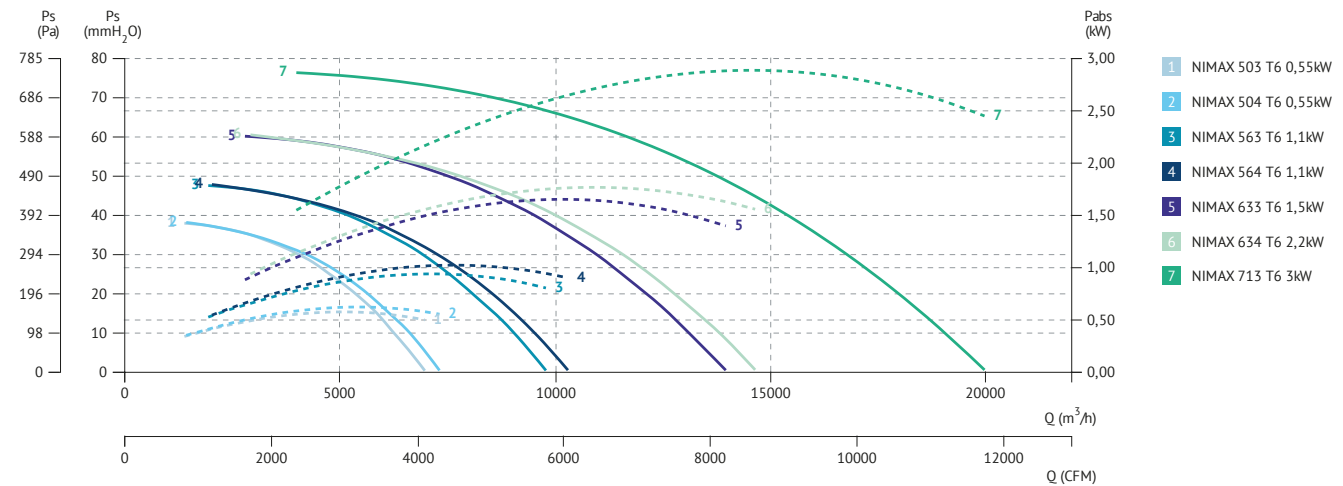

**6 POLE / 6 polos**

