



indoor air quality and energy saving

TECHNICAL DATA



CRHE-V & CRHE-V ENT



VENTILATION UNIT WITH HEAT RECOVERY FOR COMMERCIAL AND INDUSTRIAL BUILDINGS



CRHE-V

Non-residential ventilator unit with dual flow and high yield heat recovery. All sizes are available also in the version with enthalpy exchanger

PERFORMANCE

Equipped with counter current heat exchanger in aluminium (Eurovent certified) and electronic backward blade ventilators. The total bypass as standard allows favourable climatic conditions to be taken advantage of outside the building for free cooling (or free heating) in automatic mode.

STRUCTURE

CRHE-V is manufactured using a profiled extruded aluminium frame and 36 mm thick sandwich panels, insulated in polyurethane foam. The panels and inner parts are manufactured in Aluzinc,[®] material that ensures high strength against corrosion and oxidation. A panel with shutter opening eases access to the filters (ePM1 70% (F7) for the renewed air flow and ePM10 50% (G4) or ePM10 50% (M5) for the extraction air flow). CRHE-V is prepared for installation outdoors (with an optional, specific protective roof) and indoors; it is supplied with 100 mm high aluminium bases for installation on the floor. Available in 6 sizes, it can be equipped with air post-treatment systems (inside the unit) such as: hot/cold water battery, electrical heater or direct expansion battery. CRHE-V was designed to enable easy configuration of the connection to the air distribution/captation ducts. It is also possible and easy to install post-air treatment devices after sale. The pre-heater is inside, between the filter and the heat exchanger.

CONTROLLI

CRHE-V was supplied with an electric box and control system; it is available in a version equipped with EVO-PH control and a version equipped with EVOD-PH-IP control prepared for complete integration in home automation systems (Modbus protocol with Ethernet connection or, on request, with the addition of connection RS485). The new version of our control systems enables extremely easy and rapid passage from a control system to another, even after installation with the single replacement of the remote panel.

The EVO-PH control has a coloured, backlit touch screen interface with intuitive viewing of the working status of the machine. It enables precise adjustment of ventilator speed and has a weekly, time schedule for automatic management of the ventilators. It can be controlled by an external switch to activate the booster function, it can automatically adjust the air flow rate if connected to an air quality probe, it can manage any air post treatment accessories, it automatically manages the bypass and prevents heat exchanger freezing by managing the speed of the ventilators or, if installed, an electrical pre-heating resistor (optional accessory outside the machine); it signals to the user the need to replace the filters (the clogging status of the filters is monitored by a pair of different pressure switches, supplied as standard) or an anomaly, indicating the origin. With the addition of optional accessories (COP kit and CAV kit installed on the channel) you can manage the ventilation machine in constant pressure or constant flow rate mode.

The EVOD-PH-IP control has the same characteristics as the EVO-PH version with the addition of Modbus communication protocol which allows full control of the machine by the supervision software of the home automation system. The implemented webserver allows interaction with the machine, even with an internet browser of a device connected (even from remote) to the home automation system in which the machine is inserted.

ACCESSORIES

CRHE-V can be equipped with other accessories such as:

- . R.H. of probe, CO₂ or CO₂ / VOC
- . Operating kit pressure or constant flow
- . protection roof for outside installazione
- . grilles and damper

For a more complete view of the characteristics of the control panels, please read the specific manuals

CRHE-V (vertical) - SIDE VIEW

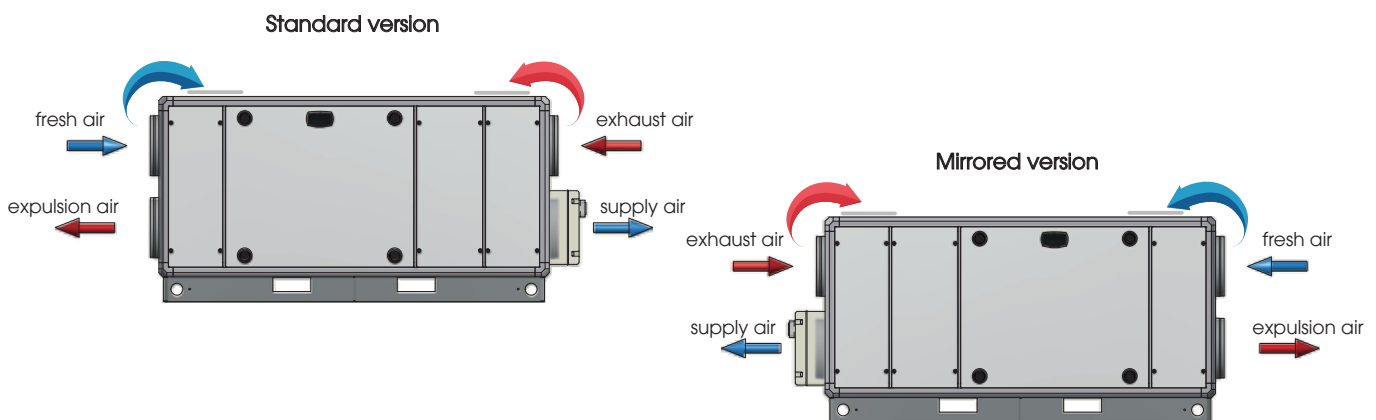

Counterflow heat exchanger made of aluminum manufactured by RECUTECH
RECUTECH participates in the Eurovent Certification Program

For the enthalpic version: counterflow heat exchanger manufactured by POLYBLOC
POLYBLOC participates in the Eurovent Certification Program



PERFORMANCE (UNI EN 13141-7)

The unit must be ducted properly: UTEK authorizes the use only according to its performance diagram shown into this catalogue
 The declared performances are with CLEAN filters, and guaranteed ONLY with the original filters UTEK low pressure drop.

CRHE-V 700 & CRHE-V 700 ENT

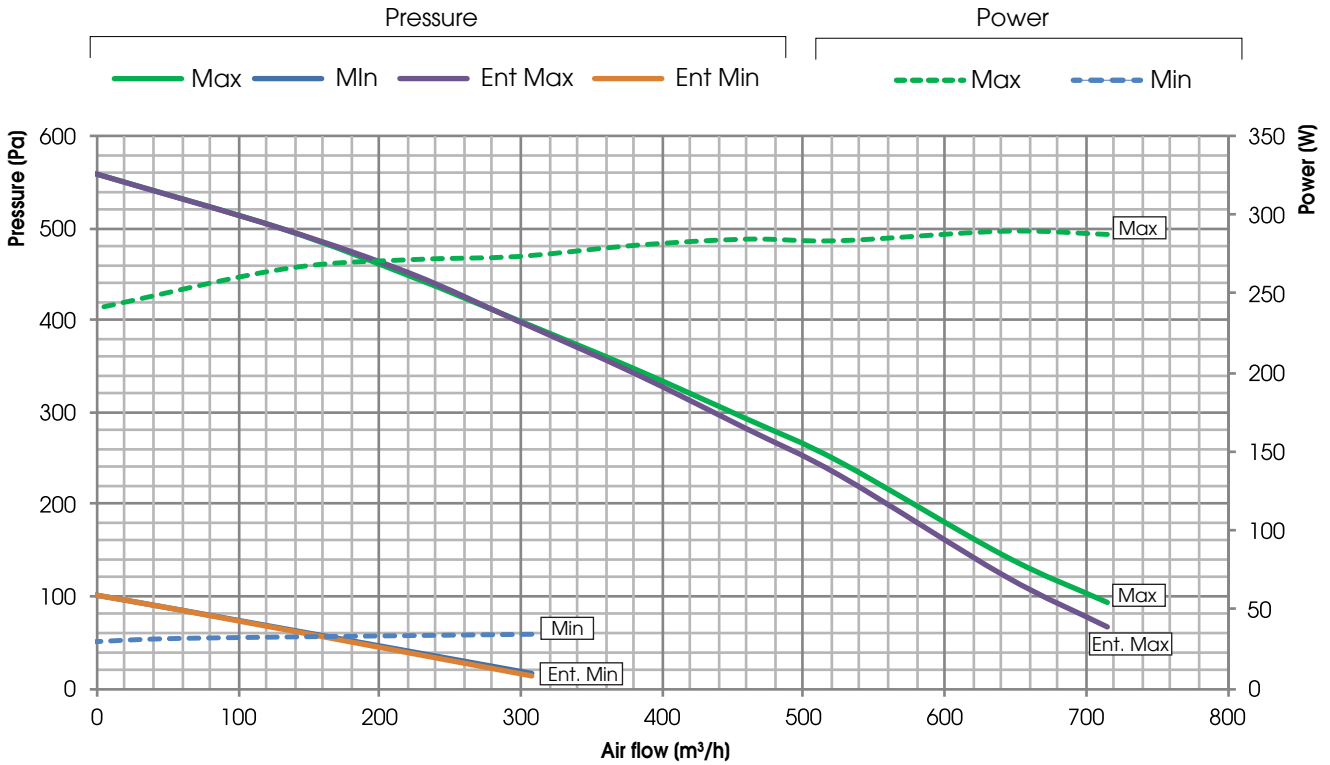

CRHE-V 1100 & CRHE-V 1100 ENT

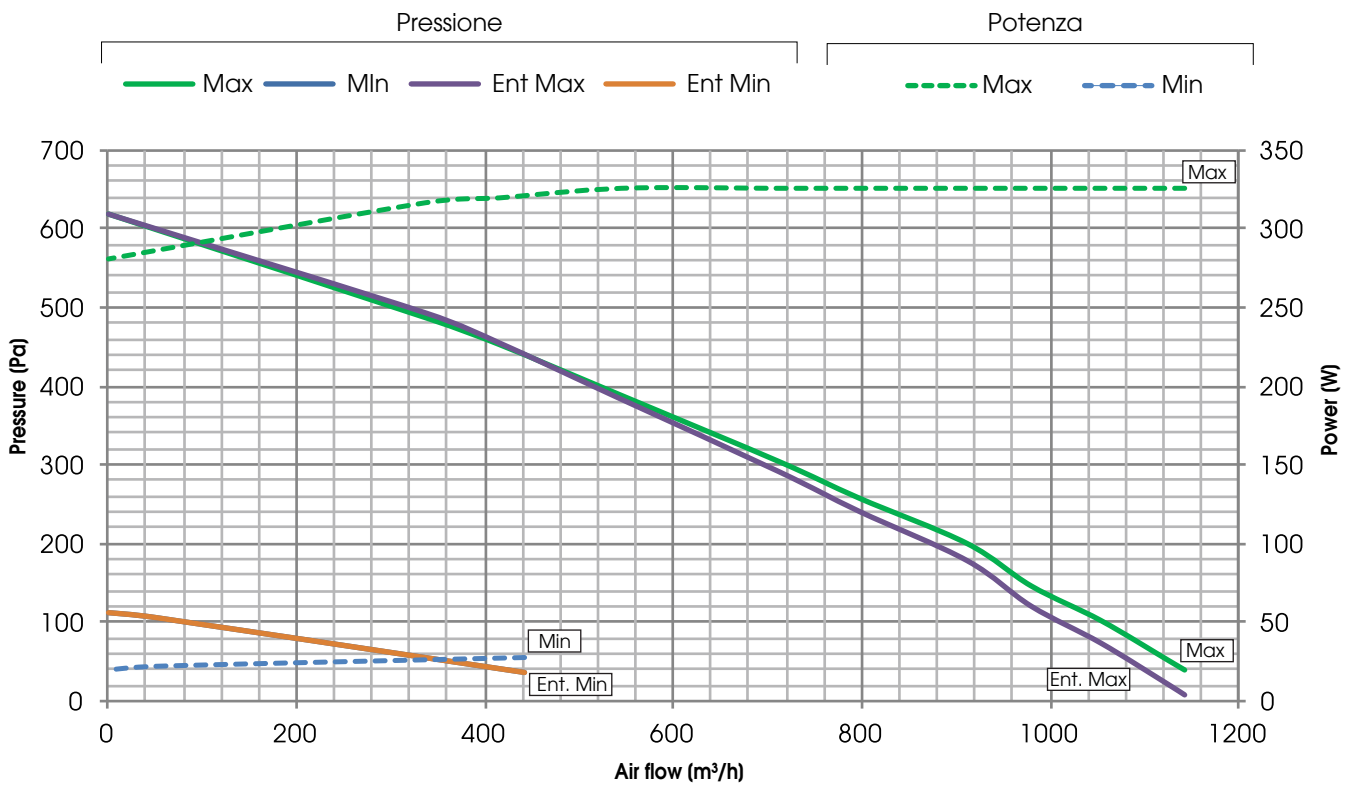



PERFORMANCE (UNI EN 13141-7)

The unit must be ducted properly; UTEK authorizes the use only according to its performance diagram shown into this catalogue
 The declared performances are with CLEAN filters, and guaranteed ONLY with the original filters UTEK low pressure drop.

CRHE-V 1600 & CRHE-V 1600 ENT

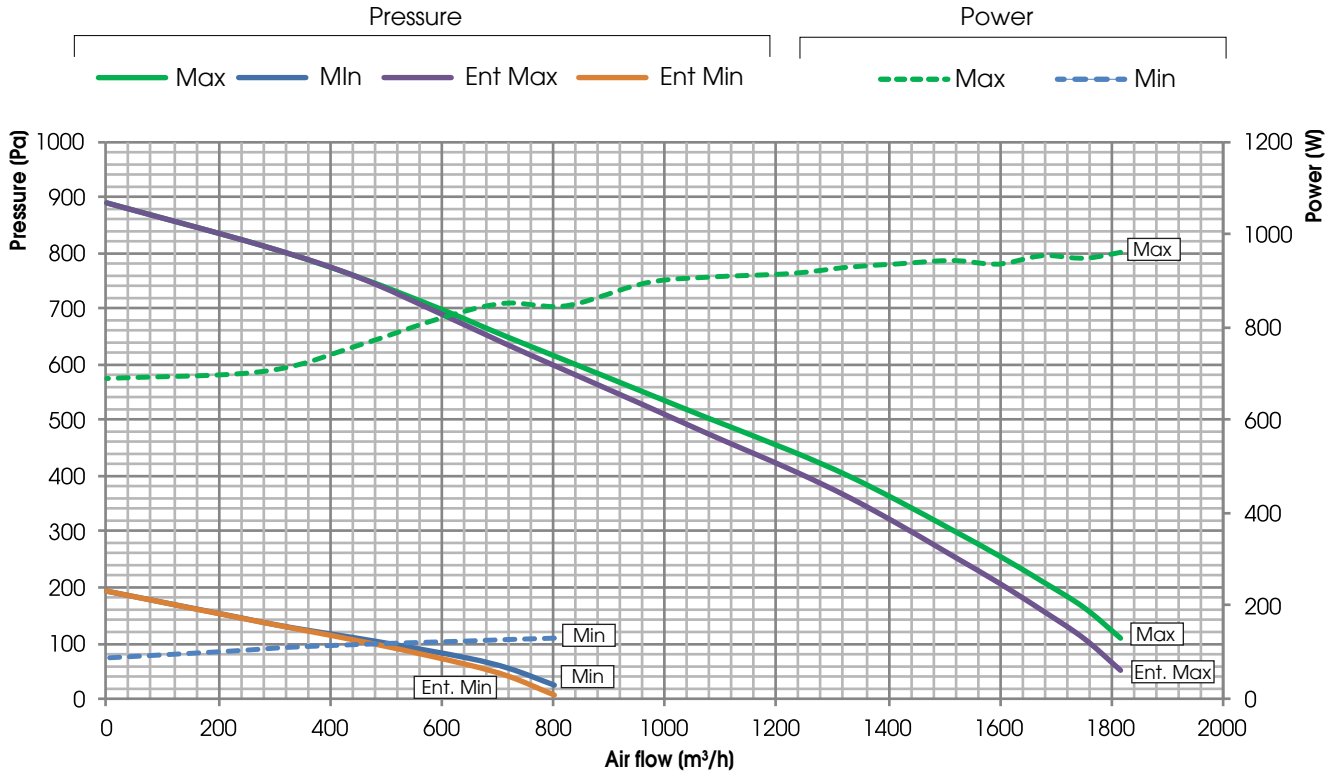

CRHE-V 2500 & CRHE-V 2500 ENT

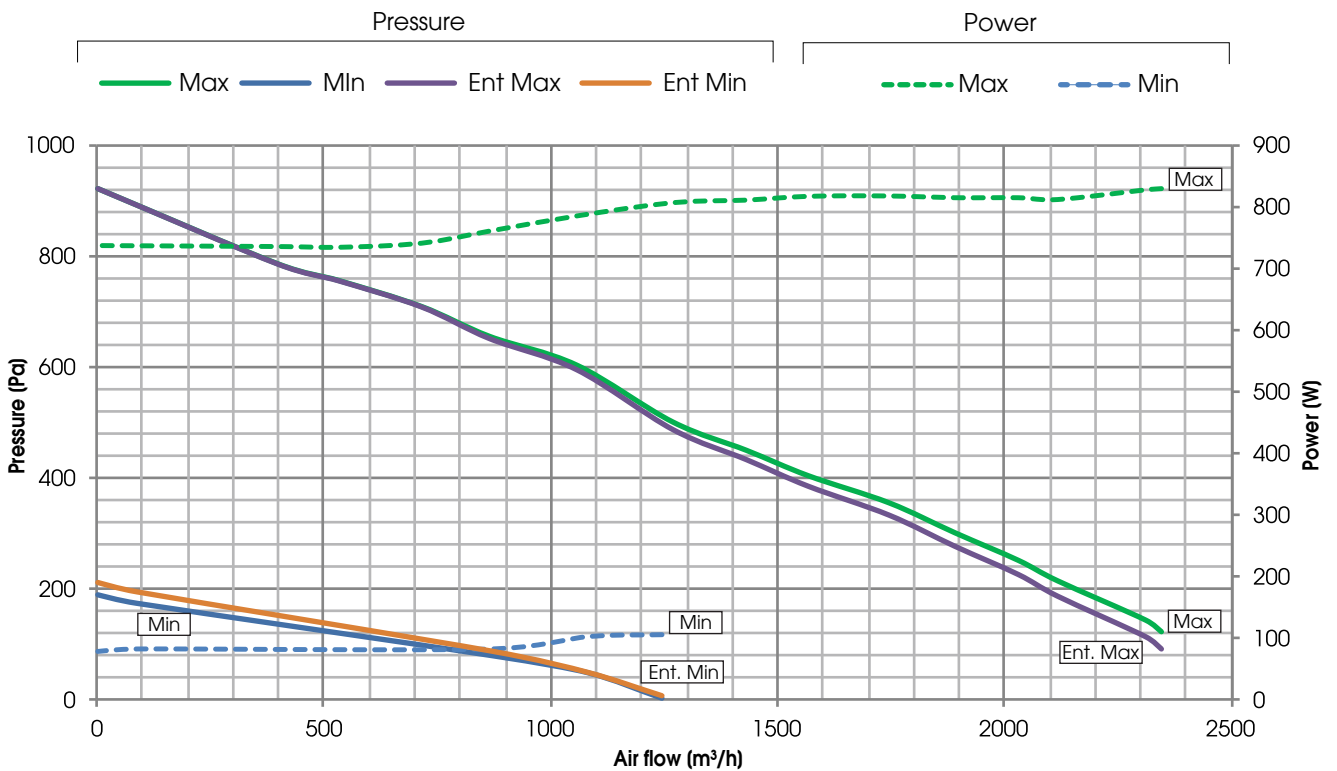



PERFORMANCE (UNI EN 13141-7)

The unit must be ducted properly: UTEK authorizes the use only according to its performance diagram shown into this catalogue
The declared performances are with CLEAN filters, and guaranteed ONLY with the original filters UTEK low pressure drop.

CRHE-V 3200 & CRHE-V 3200 ENT

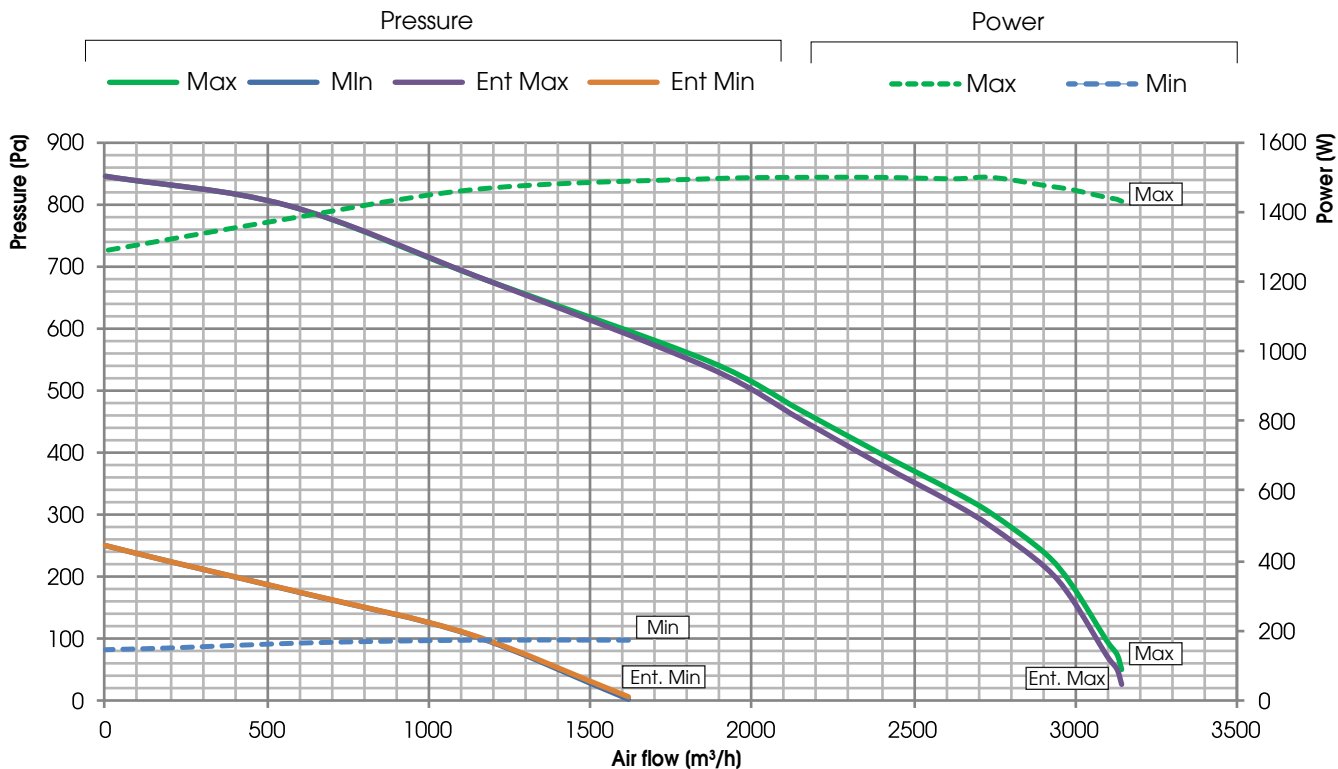

CRHE-V 4500 & CRHE-V 4500 ENT

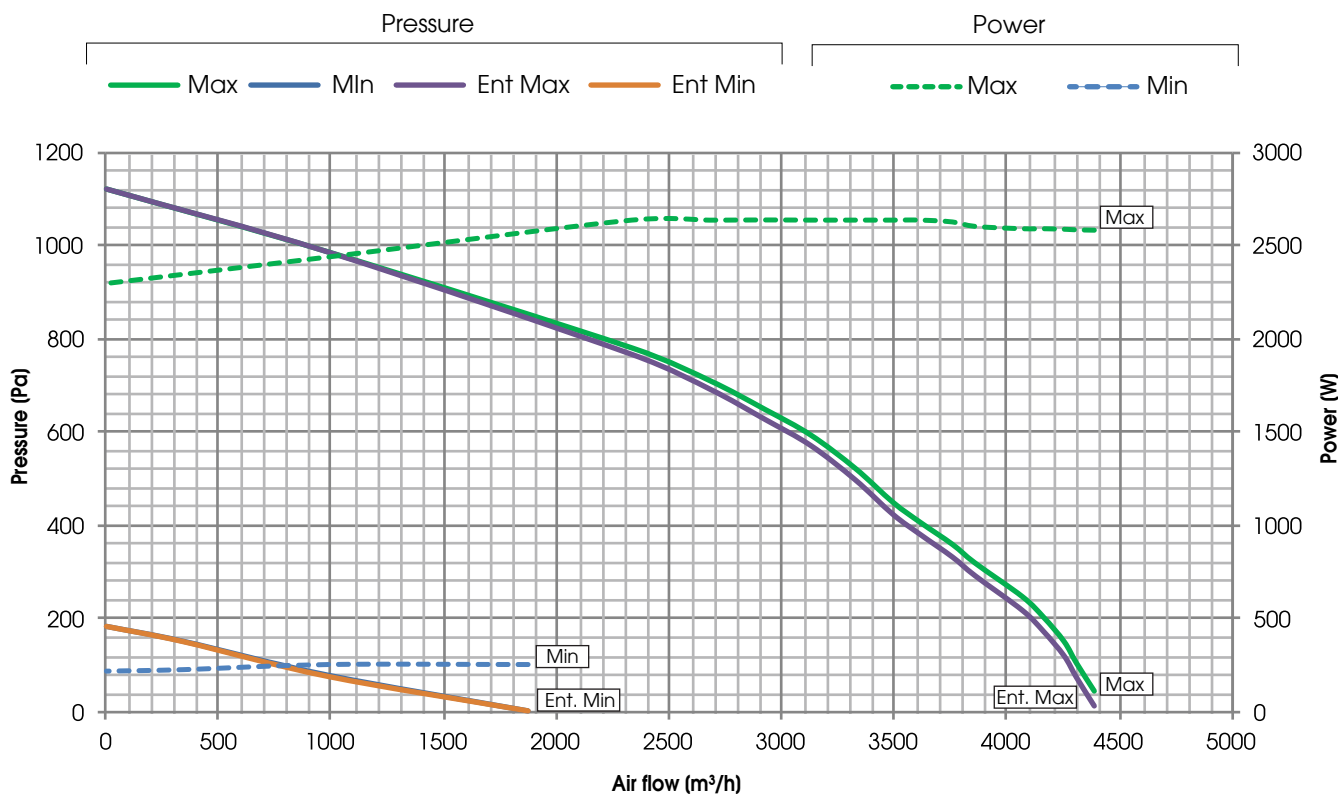



PERFORMANCE (UNI EN 13141-7)

The unit must be ducted properly: UTEK authorizes the use only according to its performance diagram shown into this catalogue
The declared performances are with CLEAN filters, and guaranteed ONLY with the original filters UTEK low pressure drop.

CRHE-V 5600 & CRHE-V 5600 ENT

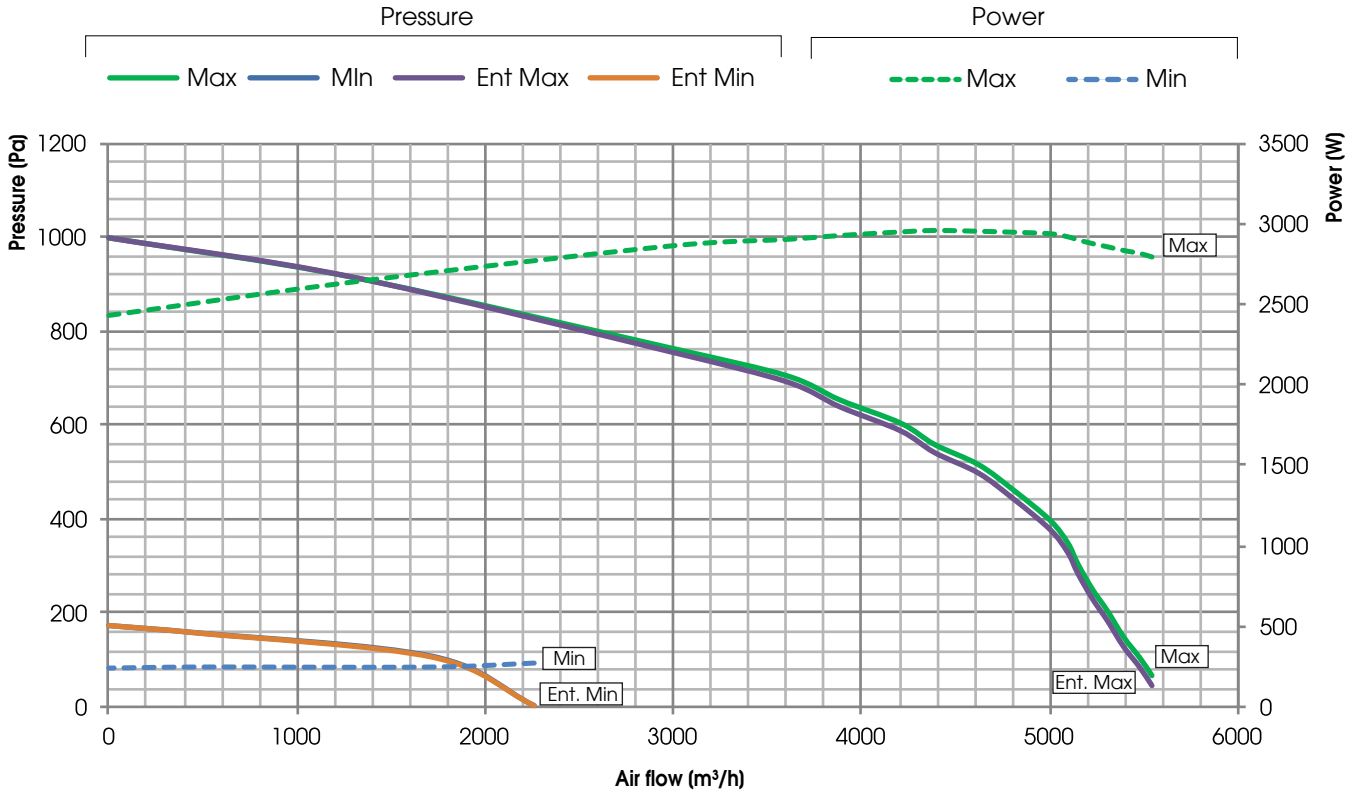

HEAT RECOVERY PERFORMANCE (sensible efficiency)

Values referred to the following conditions (UNI EN 308:1998): T_{bs} external air 5°C; U.R. external 72%; T_{bs} environment 25°C; U.R. environment 38%

- | | | | |
|-------------------|-------------------|-------------------|-------------------|
| — CRHE-V 700 | — CRHE-V 1100 | — CRHE-V 1600 | — CRHE-V 2500 |
| — CRHE-V 3200 | — CRHE-V 4500 | — CRHE-V 5600 | — CRHE-V 700 ENT |
| — CRHE-V 1100 ENT | — CRHE-V 1600 ENT | — CRHE-V 2500 ENT | — CRHE-V 3200 ENT |
| — CRHE-V 4500 ENT | — CRHE-V 5600 ENT | | |

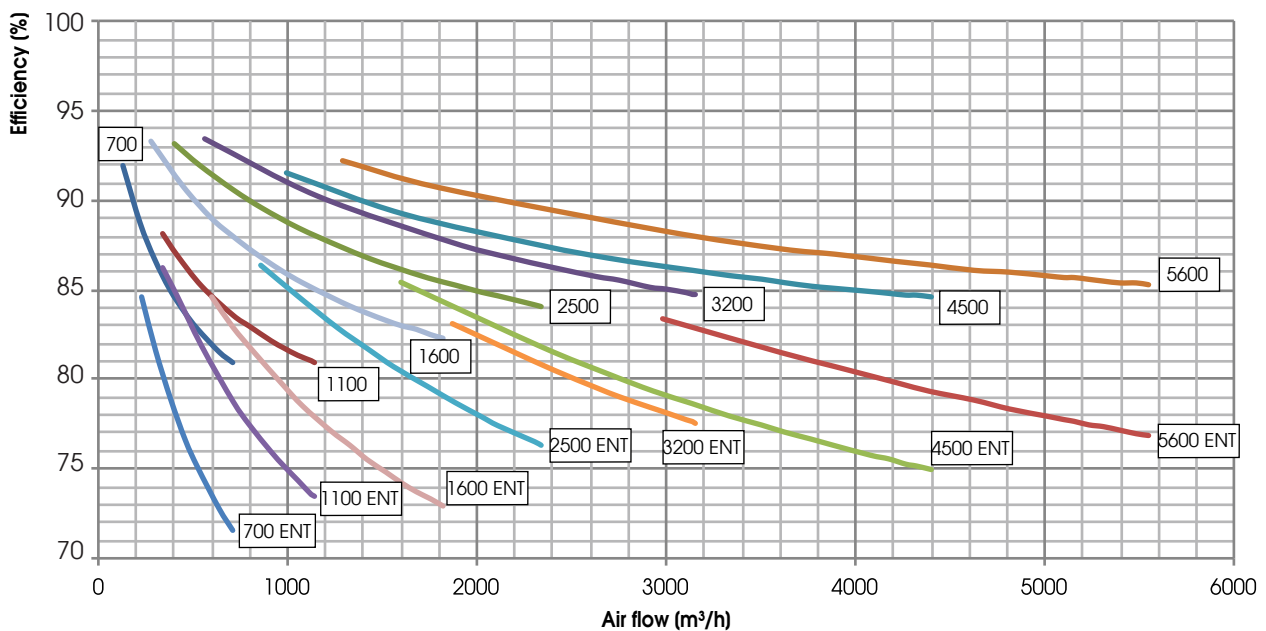



ECODESIGN

| MOD. | η_{t_nvru} (%) | q_{nom} (m ³ /s) | $\Delta p_{s,ext}$ (Pa) | P (kW) | SFP _{int} (W/(m ³ /s)) | SFP _{int_lim 2016} (W/(m ³ /s)) | SFP _{int_lim 2018} (W/(m ³ /s)) | FRONTAL SPEED (m/s) | $\Delta p_{s,int}$ (Pa) | η_{Fan} (%) | * LEAKAGE internal (%) | * LEAKAGE external (%) |
|-------------|----------------------|-------------------------------|-------------------------|--------|--|---|---|---------------------|-------------------------|------------------|------------------------|------------------------|
| CRHE-V 700 | 82,2 | 0,16 | 200 | 0,29 | 843 | 1632 | 1352 | 1,21 | 475 | 56,5 | 9,5 | 5,4 |
| CRHE-V 1100 | 82,2 | 0,25 | 200 | 0,33 | 460 | 1618 | 1338 | 1,31 | 278 | 58,5 | 7,1 | 4,6 |
| CRHE-V 1600 | 82,7 | 0,47 | 200 | 0,95 | 1103 | 1601 | 1321 | 1,56 | 697 | 63,2 | 4,5 | 2,9 |
| CRHE-V 2500 | 84,6 | 0,60 | 200 | 0,81 | 568 | 1639 | 1359 | 1,52 | 344 | 55,4 | 4,6 | 4,0 |
| CRHE-V 3200 | 85,0 | 0,83 | 200 | 1,47 | 694 | 1617 | 1337 | 1,49 | 299 | 48,3 | 3,5 | 4,2 |
| CRHE-V 4500 | 84,9 | 1,13 | 250 | 2,59 | 1040 | 1568 | 1288 | 2,00 | 480 | 51,4 | 2,8 | 3,6 |
| CRHE-V 5600 | 85,6 | 1,45 | 250 | 2,88 | 782 | 1540 | 1260 | 1,80 | 370 | 54,0 | 2,3 | 3,0 |

* Compared to q_{nom}

ECODESIGN CRHE ENTALPICO

| MOD. | η_{t_nvru} (%) | q_{nom} (m ³ /s) | $\Delta p_{s,ext}$ (Pa) | P (kW) | SFP _{int} (W/(m ³ /s)) | SFP _{int_lim 2016} (W/(m ³ /s)) | SFP _{int_lim 2018} (W/(m ³ /s)) | FRONTAL SPEED (m/s) | $\Delta p_{s,int}$ (Pa) | η_{Fan} (%) | * LEAKAGE internal (%) | * LEAKAGE external (%) |
|-----------------|----------------------|-------------------------------|-------------------------|--------|--|---|---|---------------------|-------------------------|------------------|------------------------|------------------------|
| CRHE-V 700/ENT | 74,4 | 0,16 | 200 | 0,28 | 872 | 1400 | 1120 | 1,17 | 488 | 55,8 | 9,8 | 5,5 |
| CRHE-V 1100/ENT | 76,5 | 0,24 | 200 | 0,32 | 544 | 1449 | 1169 | 1,25 | 321 | 59,0 | 7,4 | 4,8 |
| CRHE-V 1600/ENT | 75,3 | 0,40 | 300 | 0,94 | 1057 | 1389 | 1109 | 2,07 | 654 | 62,5 | 4,5 | 2,9 |
| CRHE-V 2500/ENT | 77,6 | 0,58 | 200 | 0,81 | 691 | 1430 | 1150 | 1,48 | 399 | 57,8 | 4,7 | 4,1 |
| CRHE-V 3200/ENT | 78,3 | 0,81 | 200 | 1,47 | 754 | 1417 | 1137 | 1,48 | 336 | 49,1 | 3,6 | 4,2 |
| CRHE-V 4500/ENT | 76,7 | 1,03 | 350 | 2,62 | 1009 | 1337 | 1057 | 1,83 | 523 | 56,1 | 3,0 | 3,9 |
| CRHE-V 5600/ENT | 77,5 | 1,44 | 250 | 2,88 | 815 | 1298 | 1018 | 1,79 | 390 | 54,7 | 2,3 | 3,0 |

* Compared to q_{nom}

VALUES ACCORDING UNI EN 1886: 2008

| MOD. | CASING STRENGTH | CASING LEAKAGE | FILTER CLASS | THERMAL TRANSMITTANCE | THERMAL BRIDGE |
|-----------------|-----------------|----------------|-------------------|-----------------------|----------------|
| CRHE-V 700/ENT | D1 (M) | L3 (M) | ePM1 70% (F7) (M) | T4 (M) | TB3 (M) |
| CRHE-V 1100/ENT | D1 (M) | L3 (M) | ePM1 70% (F7) (M) | T4 (M) | TB3 (M) |
| CRHE-V 1600/ENT | D1 (M) | L3 (M) | ePM1 70% (F7) (M) | T4 (M) | TB3 (M) |
| CRHE-V 2500/ENT | D1 (M) | L3 (M) | ePM1 70% (F7) (M) | T4 (M) | TB3 (M) |
| CRHE-V 3200/ENT | D1 (M) | L3 (M) | ePM1 70% (F7) (M) | T4 (M) | TB3 (M) |
| CRHE-V 4500/ENT | D1 (M) | L3 (M) | ePM1 70% (F7) (M) | T4 (M) | TB3 (M) |
| CRHE-V 5600/ENT | D1 (M) | L3 (M) | ePM1 70% (F7) (M) | T4 (M) | TB3 (M) |

TEST LEAKAGE (UNI EN 13141-7)

| LEAKAGE | TEST CONDITIONS | LEAKAGE CLASSIFICATION | | | | | | |
|---------|----------------------------|------------------------|-----------------|-----------------|-----------------|-----------------|-----------------|-----------------|
| | | CRHE-V 700/ENT | CRHE-V 1600/ENT | CRHE-V 1100/ENT | CRHE-V 2500/ENT | CRHE-V 3200/ENT | CRHE-V 4500/ENT | CRHE-V 5600/ENT |
| OUTDOOR | Positive pressure 400 Pa | A2 | A2 | A2 | A2 | A2 | A2 | A2 |
| OUTDOOR | Negative pressure 400 Pa | A2 | A2 | A2 | A2 | A2 | A1 | A1 |
| INDOOR | Pressure difference 250 Pa | A3 | A2 | A3 | A2 | A2 | A2 | A2 |

NOISE LEVEL

L_w Sound level taken in accordance to UNI EN ISO 3747
($\Delta L_f A \geq 7$ dB for each measurement position, class accuracy 2)

| CRHE-V 700/ENT | NOISE FROM THE CASE (dB) | | | | | | | |
|-----------------|--------------------------|--------|--------|---------|---------|---------|---------|----------------------|
| | 125 Hz | 250 Hz | 500 Hz | 1000 Hz | 2000 Hz | 4000 Hz | 8000 Hz | L _w dB(A) |
| | 59 | 59 | 45 | 42 | 38 | 32 | 29 | 52,2 |
| CRHE-V 700/ENT | NOISE IN THE DUCTS (dB) | | | | | | | |
| | 125 Hz | 250 Hz | 500 Hz | 1000 Hz | 2000 Hz | 4000 Hz | 8000 Hz | L _w dB(A) |
| | 65 | 59 | 48 | 49 | 46 | 44 | 42 | 55,9 |
| CRHE-V 1100/ENT | NOISE FROM THE CASE (dB) | | | | | | | |
| | 125 Hz | 250 Hz | 500 Hz | 1000 Hz | 2000 Hz | 4000 Hz | 8000 Hz | L _w dB(A) |
| | 60 | 57 | 44 | 44 | 39 | 27 | 18 | 51,4 |
| CRHE-V 1100/ENT | NOISE IN THE DUCTS (dB) | | | | | | | |
| | 125 Hz | 250 Hz | 500 Hz | 1000 Hz | 2000 Hz | 4000 Hz | 8000 Hz | L _w dB(A) |
| | 64 | 62 | 48 | 49 | 45 | 35 | 31 | 56,2 |



| CRHE-V 1600/ENT | NOISE FROM THE CASE (dB) | | | | | | | |
|-----------------|--------------------------|--------|--------|---------|---------|---------|---------|----------------------|
| | 125 Hz | 250 Hz | 500 Hz | 1000 Hz | 2000 Hz | 4000 Hz | 8000 Hz | L _w dB(A) |
| | 70,3 | 64 | 49,2 | 46,8 | 43,1 | 33,2 | 25,3 | 58,6 |
| CRHE-V 1600/ENT | NOISE IN THE DUCTS (dB) | | | | | | | |
| | 125 Hz | 250 Hz | 500 Hz | 1000 Hz | 2000 Hz | 4000 Hz | 8000 Hz | L _w dB(A) |
| | 73,7 | 66,6 | 56,0 | 58,5 | 56,5 | 53,1 | 46,3 | 64,7 |
| CRHE-V 2500/ENT | NOISE FROM THE CASE (dB) | | | | | | | |
| | 125 Hz | 250 Hz | 500 Hz | 1000 Hz | 2000 Hz | 4000 Hz | 8000 Hz | L _w dB(A) |
| | 63 | 64 | 53 | 55 | 49 | 42 | 30 | 59,8 |
| CRHE-V 2500/ENT | NOISE IN THE DUCTS (dB) | | | | | | | |
| | 125 Hz | 250 Hz | 500 Hz | 1000 Hz | 2000 Hz | 4000 Hz | 8000 Hz | L _w dB(A) |
| | 67 | 69 | 57 | 60 | 55 | 50 | 43 | 64,8 |
| CRHE-V 3200/ENT | NOISE FROM THE CASE (dB) | | | | | | | |
| | 125 Hz | 250 Hz | 500 Hz | 1000 Hz | 2000 Hz | 4000 Hz | 8000 Hz | L _w dB(A) |
| | 64 | 68 | 56 | 58 | 52 | 46 | 36 | 63,2 |
| CRHE-V 3200/ENT | NOISE IN THE DUCTS (dB) | | | | | | | |
| | 125 Hz | 250 Hz | 500 Hz | 1000 Hz | 2000 Hz | 4000 Hz | 8000 Hz | L _w dB(A) |
| | 68 | 73 | 61 | 63 | 59 | 55 | 49 | 68,4 |
| CRHE-V 4500/ENT | NOISE FROM THE CASE (dB) | | | | | | | |
| | 125 Hz | 250 Hz | 500 Hz | 1000 Hz | 2000 Hz | 4000 Hz | 8000 Hz | L _w dB(A) |
| | 70 | 74 | 61 | 64 | 56 | 49 | 38 | 68,4 |
| CRHE-V 4500/ENT | NOISE IN THE DUCTS (dB) | | | | | | | |
| | 125 Hz | 250 Hz | 500 Hz | 1000 Hz | 2000 Hz | 4000 Hz | 8000 Hz | L _w dB(A) |
| | 74 | 78 | 66 | 69 | 62 | 57 | 51 | 73,4 |
| CRHE-V 5600/ENT | NOISE FROM THE CASE (dB) | | | | | | | |
| | 125 Hz | 250 Hz | 500 Hz | 1000 Hz | 2000 Hz | 4000 Hz | 8000 Hz | L _w dB(A) |
| | 72 | 81 | 61 | 62 | 54 | 47 | 37 | 73,3 |
| CRHE-V 5600/ENT | NOISE IN THE DUCTS (dB) | | | | | | | |
| | 125 Hz | 250 Hz | 500 Hz | 1000 Hz | 2000 Hz | 4000 Hz | 8000 Hz | L _w dB(A) |
| | 76 | 86 | 66 | 67 | 61 | 56 | 50 | 77,9 |

ELECTRICAL DATA

| MATCHING | FANS | | | | UNIT CRHE-V | | |
|-----------------|-----------|------------------|-----------------|------------------|---------------|-----------------|------------------|
| | Power (W) | Supply | Current max.(A) | Insulation class | Supply | Current max.(A) | Insulation class |
| CRHE-V 700/ENT | 2 x 145 | 230V 50/60 Hz 1F | 2 x 1,20 | IP54 CLASS B | 230V 50 Hz 1F | 2,5 | IP 20 |
| CRHE-V 1100/ENT | 2 x 170 | 230V 50/60 Hz 1F | 2 x 1,40 | IP54 CLASS B | 230V 50 Hz 1F | 2,9 | IP 20 |
| CRHE-V 1600/ENT | 2 x 448 | 230V 50/60 Hz 1F | 2 x 2,80 | IP54 CLASS B | 230V 50 Hz 1F | 5,7 | IP 20 |
| CRHE-V 2500/ENT | 2 x 448 | 230V 50/60 Hz 1F | 2 x 2,80 | IP54 CLASS B | 230V 50 Hz 1F | 5,7 | IP 20 |
| CRHE-V 3200/ENT | 2 x 715 | 230V 50/60 Hz 1F | 2 x 3,10 | IP54 CLASS B | 230V 50 Hz 1F | 6,3 | IP 20 |
| CRHE-V 4500/ENT | 2 x 1270 | 230V 50/60 Hz 1F | 2 x 5,60 | IP54 CLASS B | 230V 50 Hz 1F | 11,3 | IP 20 |
| CRHE-V 5600/ENT | 2 x 1400 | 230V 50/60 Hz 1F | 2 x 6,00 | IP54 CLASS B | 230V 50 Hz 1F | 12,1 | IP 20 |



DIMENSIONS (mm) WEIGHT (kg)

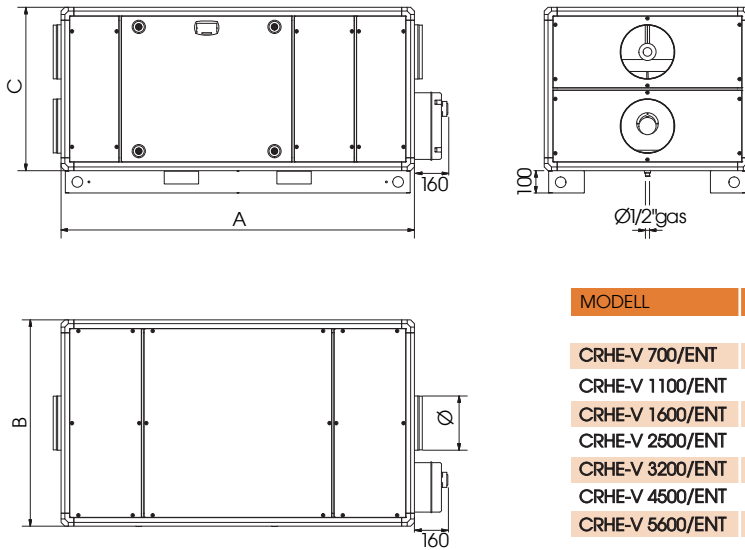

| MODELL | Dimensions (mm) | | | | |
|-----------------|-----------------|------|------|-----|-------------|
| | A | B | C | Ø | Weight (kg) |
| CRHE-V 700/ENT | 1475 | 760 | 660 | 200 | 104 |
| CRHE-V 1100/ENT | 1645 | 960 | 760 | 250 | 140 |
| CRHE-V 1600/ENT | 2000 | 970 | 980 | 355 | 222 |
| CRHE-V 2500/ENT | 2150 | 1060 | 1180 | 355 | 268 |
| CRHE-V 3200/ENT | 2305 | 1460 | 1180 | 450 | 352 |
| CRHE-V 4500/ENT | 2465 | 1360 | 1320 | 500 | 406 |
| CRHE-V 5600/ENT | 2545 | 1910 | 1320 | 560 | 674 |

INSTALLATION CRHE-V FLOOR INSTALLATION

■ Minimum required space for maintenance (mm)

| MODELL | Dimensions (mm) | | | |
|-----------------|-----------------|------|-----|-----|
| | A | B | D | E |
| CRHE-V 700/ENT | 760 | 985 | 420 | 240 |
| CRHE-V 1100/ENT | 860 | 1125 | 470 | 270 |
| CRHE-V 1600/ENT | 1080 | 1320 | 600 | 400 |
| CRHE-V 2500/ENT | 1280 | 1550 | 680 | 350 |
| CRHE-V 3200/ENT | 1280 | 1625 | 680 | 430 |
| CRHE-V 4500/ENT | 1420 | 1785 | 750 | 430 |
| CRHE-V 5600/ENT | 1420 | 1865 | 750 | 430 |

| MODELL | Dimensions (mm) | | |
|-----------------|-----------------|-----|-----|
| | C | E | F |
| CRHE-V 700/ENT | 800 | 240 | 460 |
| CRHE-V 1100/ENT | 850 | 270 | 510 |
| CRHE-V 1600/ENT | 1000 | 430 | 630 |
| CRHE-V 2500/ENT | 950 | 350 | 720 |
| CRHE-V 3200/ENT | 1320 | 430 | 720 |
| CRHE-V 4500/ENT | 1320 | 430 | 790 |
| CRHE-V 5600/ENT | 1830 | 430 | 790 |

maintenance and replacement of water coil or electric heater

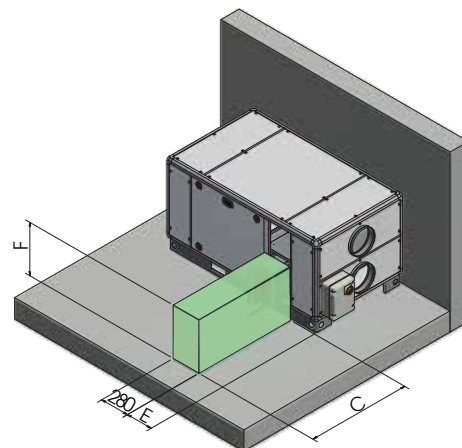
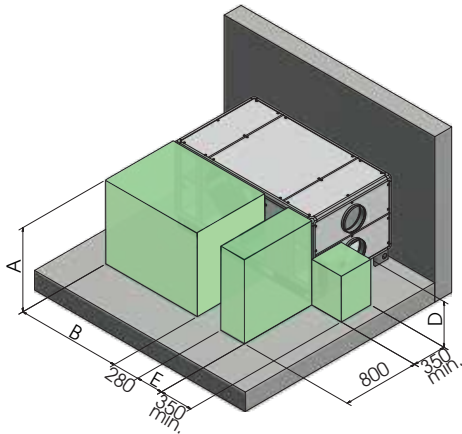

STANDARD SIPHON (mm)

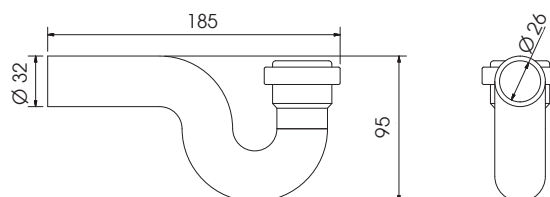

N.B.: provide for 1 additional siphon if the BA-AF / AC or DX gas cold-water coil is used



The way to read the graphs is specified within the accessories technolisto.

COILS CRHE-V 700/ENT
Cooling water coil (7°C/12°C)

| Ø WATER (”gas) | N. ROWS | FIN PITCH (mm) | INT.VOL. (dm³) | MATERIALS | | |
|----------------|---------|----------------|----------------|-----------|------|-------|
| | | | | TUBES | FINS | FRAME |
| 1/2” | 4 | 2,5 | 2 | Cu | Al | Fe Zn |

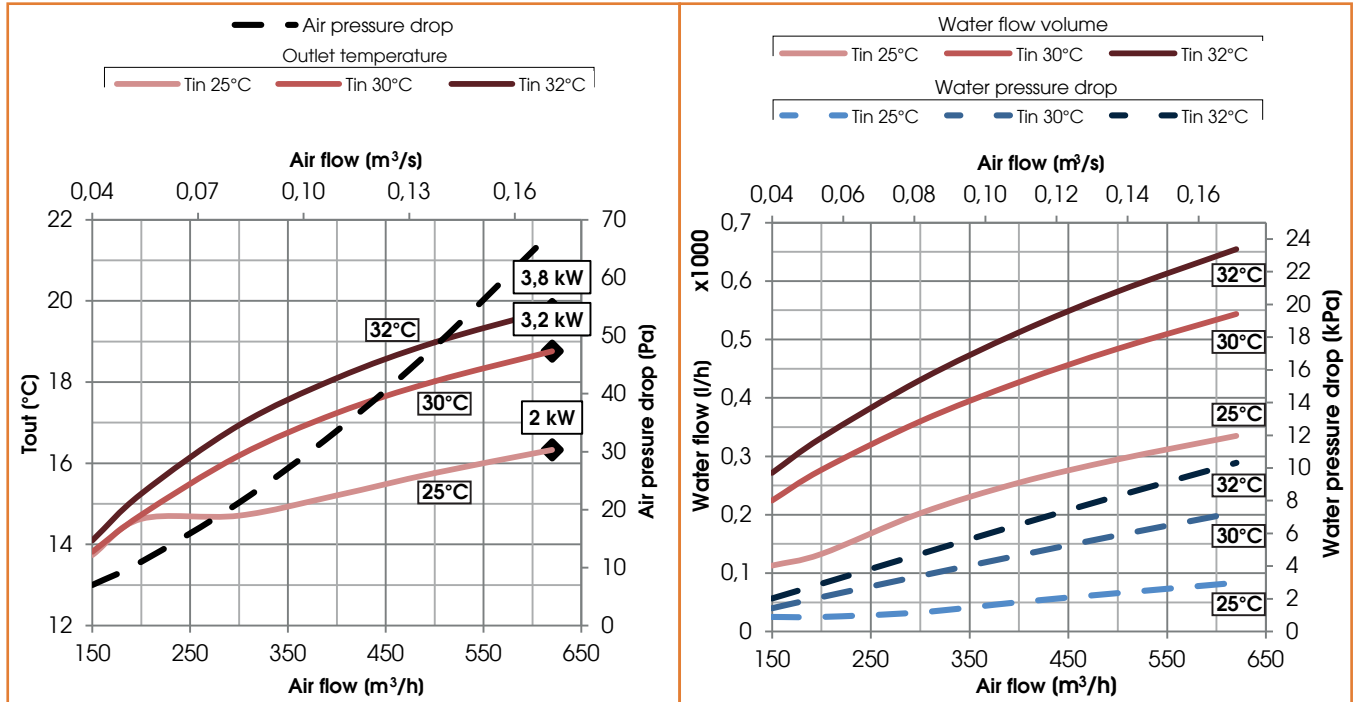

Heating water coil (45°C/35°C)

| Ø WATER (”gas) | N. ROWS | FIN PITCH (mm) | INT.VOL. (dm³) | MATERIALS | | |
|----------------|---------|----------------|----------------|-----------|------|-------|
| | | | | TUBES | FINS | FRAME |
| 1/2” | 4 | 2,5 | 2 | Cu | Al | Fe Zn |

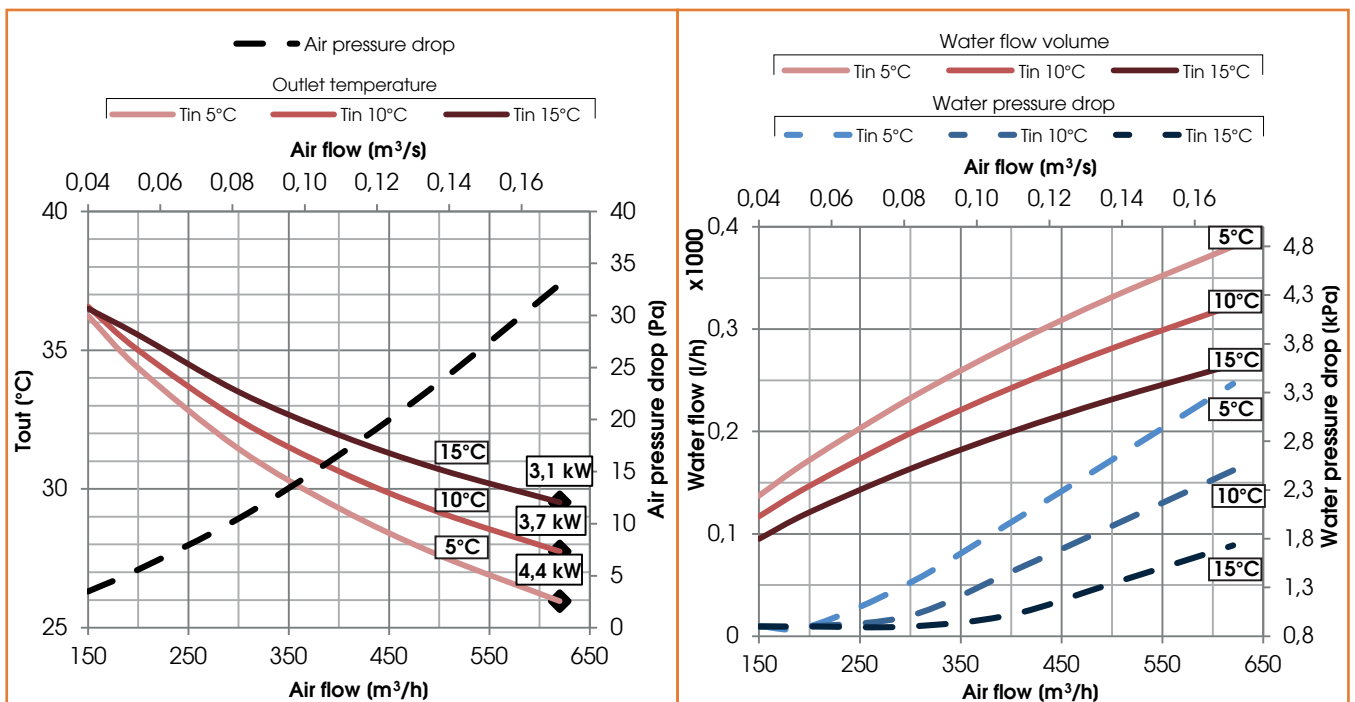



COILS CRHE-V 1100/ENT
Cooling water coil (7°C/12°C)

| Ø WATER ("gas) | N. ROWS | FIN PITCH (mm) | INT.VOL. (dm³) | MATERIALS | | |
|----------------|---------|----------------|----------------|-----------|------|-------|
| | | | | TUBES | FINS | FRAME |
| 3/4" | 4 | 2,5 | 3 | Cu | Al | Fe Zn |

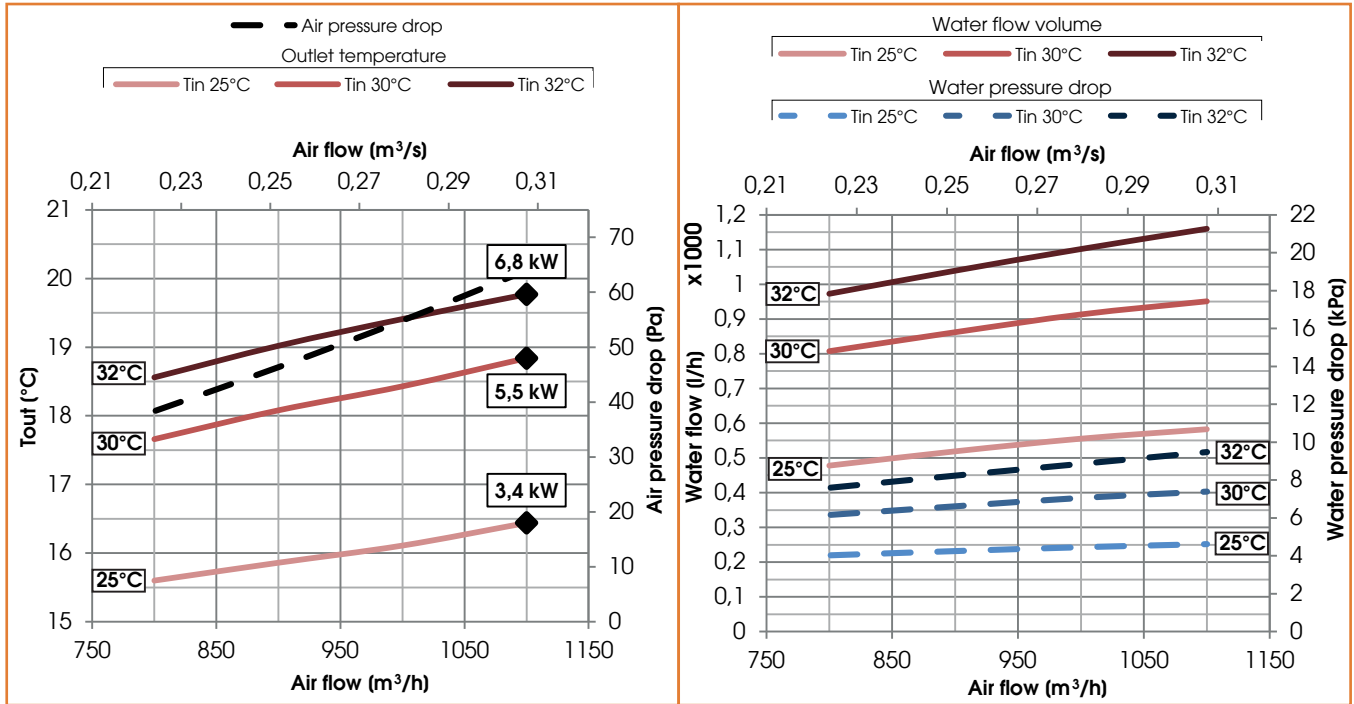

Heating water coil (45°C/35°C)

| Ø WATER ("gas) | N. ROWS | FIN PITCH (mm) | INT.VOL. (dm³) | MATERIALS | | |
|----------------|---------|----------------|----------------|-----------|------|-------|
| | | | | TUBES | FINS | FRAME |
| 3/4" | 4 | 2,5 | 3 | Cu | Al | Fe Zn |

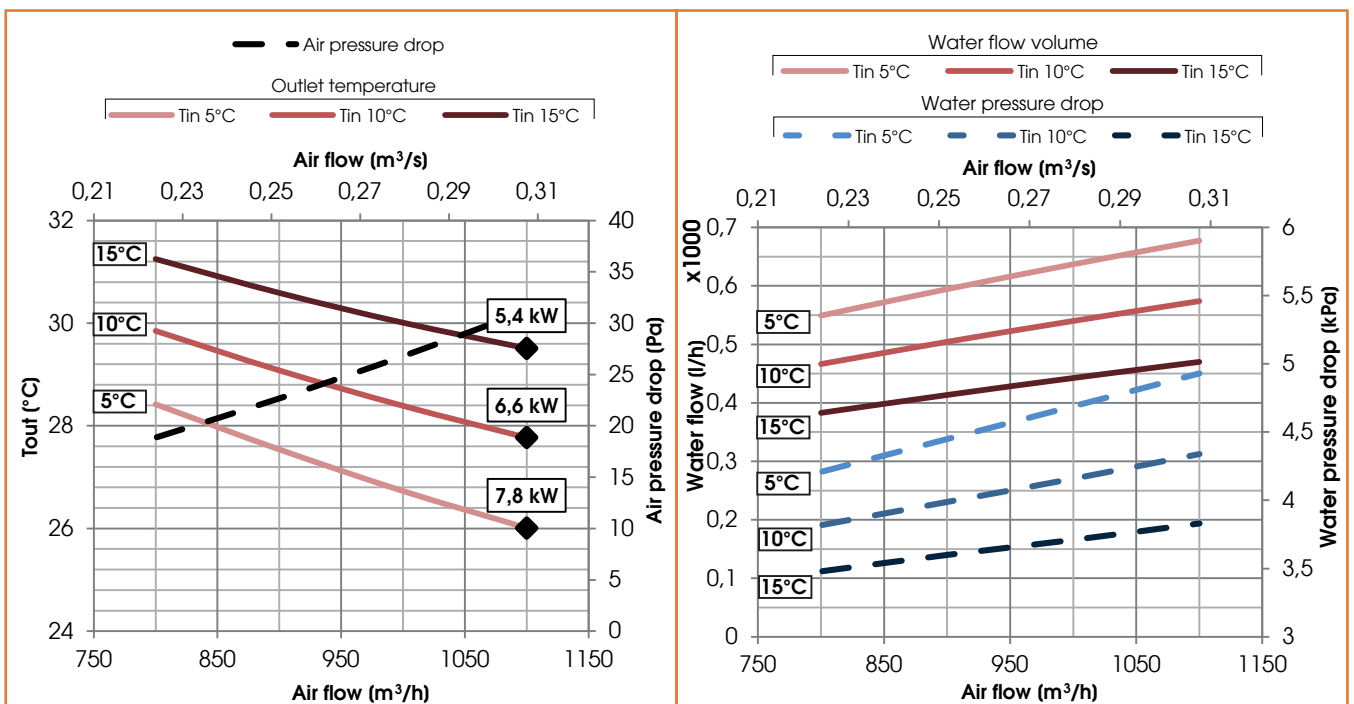



BATTERIE CRHE-V 1600/ENT
Cooling water coil (7°C/12°C)

| Ø WATER ("gas) | N. ROWS | FIN PITCH (mm) | INT.VOL. (dm³) | MATERIAL | | |
|----------------|---------|----------------|----------------|----------|------|-------|
| | | | | TUBES | FINS | FRAME |
| 3/4" | 4 | 2,5 | 5 | Cu | Al | Fe Zn |

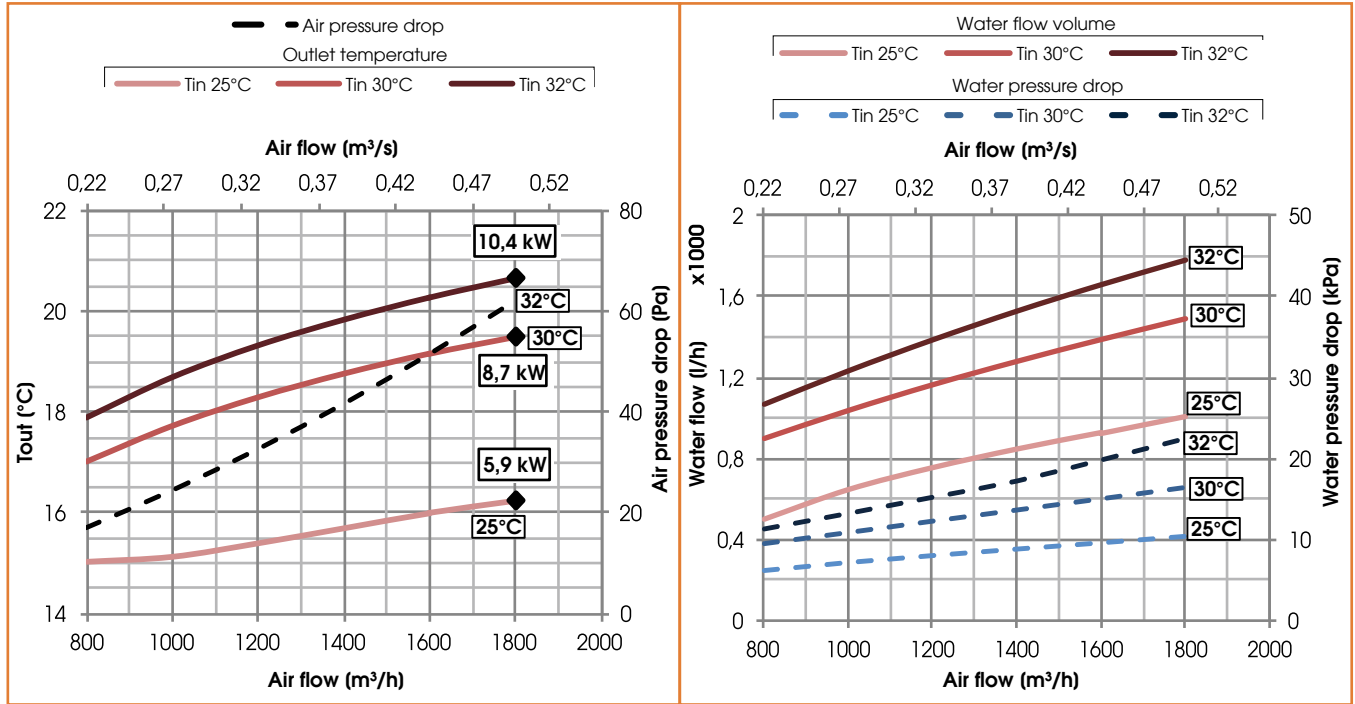

Heating water coil (45°C/35°C)

| Ø WATER ("gas) | N. ROWS | FIN PITCH (mm) | INT.VOL. (dm³) | MATERIAL | | |
|----------------|---------|----------------|----------------|----------|------|-------|
| | | | | TUBES | FINS | FRAME |
| 3/4" | 4 | 2,5 | 5 | Cu | Al | Fe Zn |

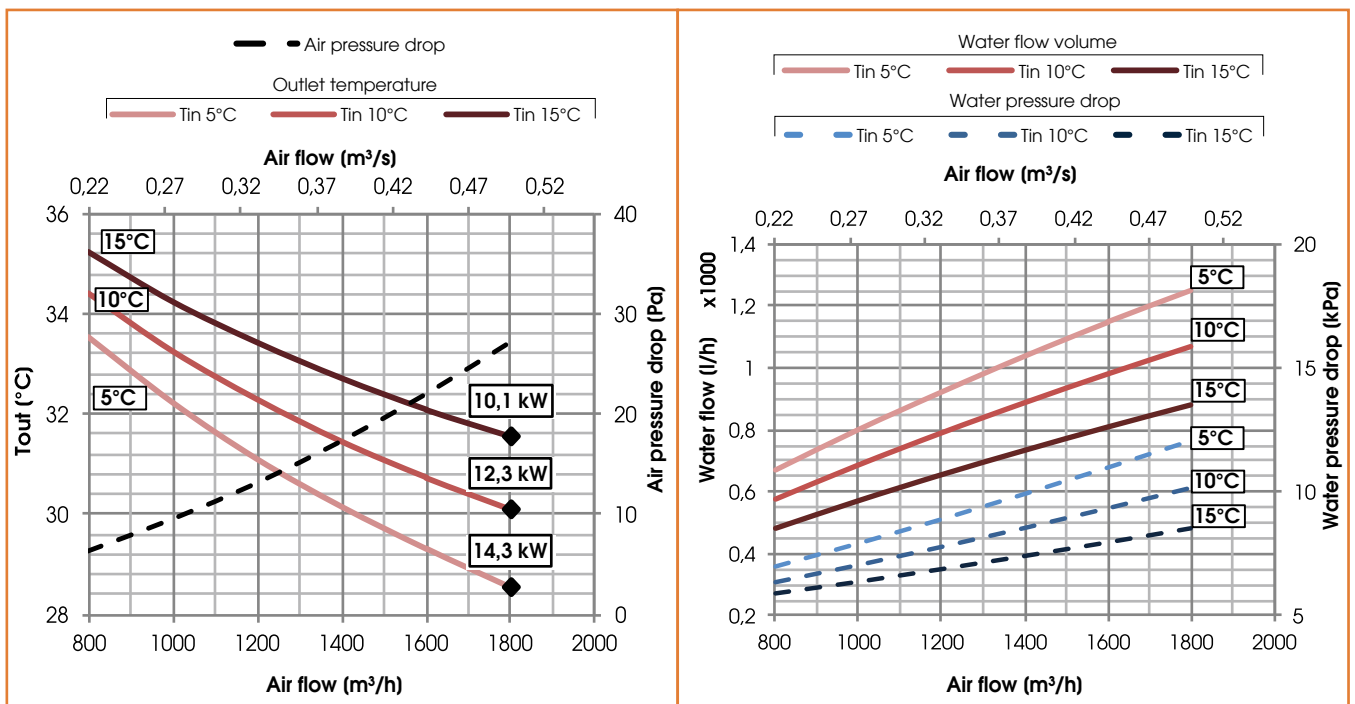



COILS CRHE-V 2500/ENT
Cooling water coil (7°C/12°C)

| Ø WATER ("gas) | N. ROWS | FIN PITCH (mm) | INT.VOL. (dm³) | MATERIALS | | |
|----------------|---------|----------------|----------------|-----------|------|-------|
| | | | | TUBES | FINS | FRAME |
| 3/4" | 4 | 2,5 | 6 | Cu | Al | Fe Zn |

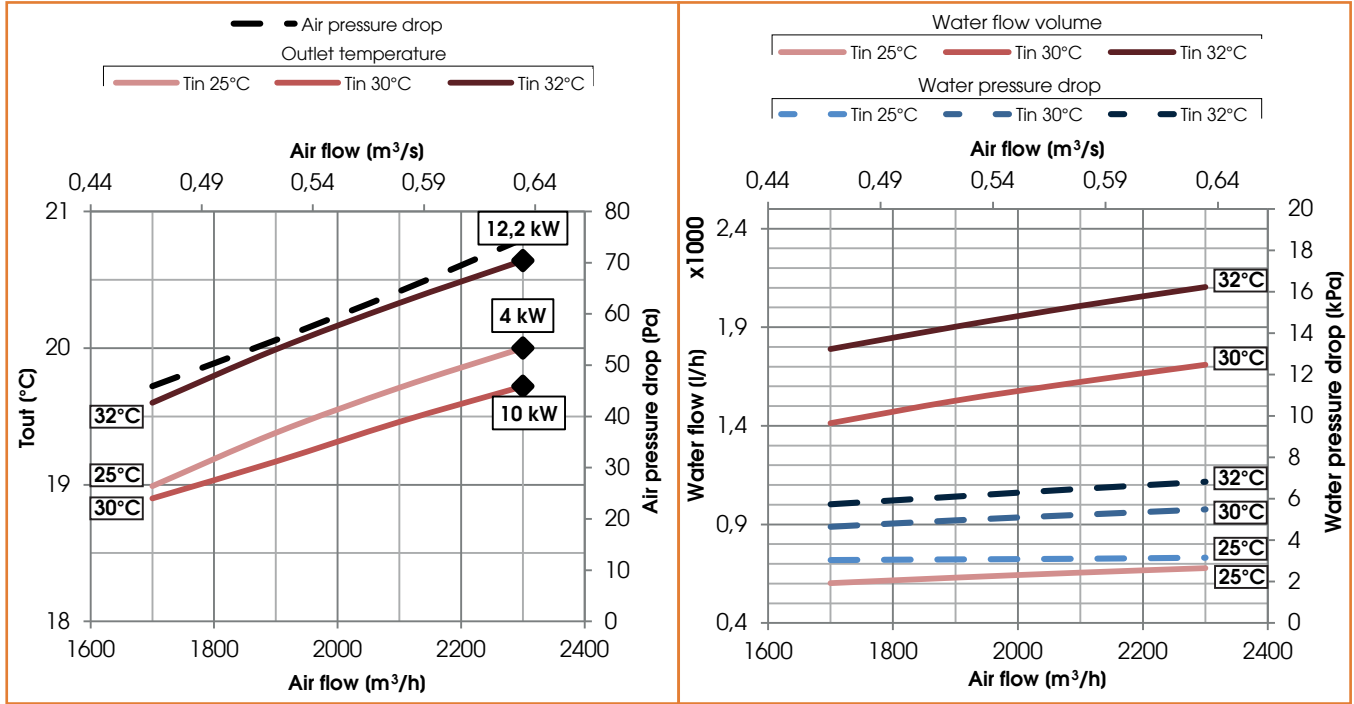

Heating water coil (45°C/35°C)

| Ø WATER ("gas) | N. ROWS | FIN PITCH (mm) | INT.VOL. (dm³) | MATERIALS | | |
|----------------|---------|----------------|----------------|-----------|------|-------|
| | | | | TUBES | FINS | FRAME |
| 3/4" | 4 | 2,5 | 6 | Cu | Al | Fe Zn |

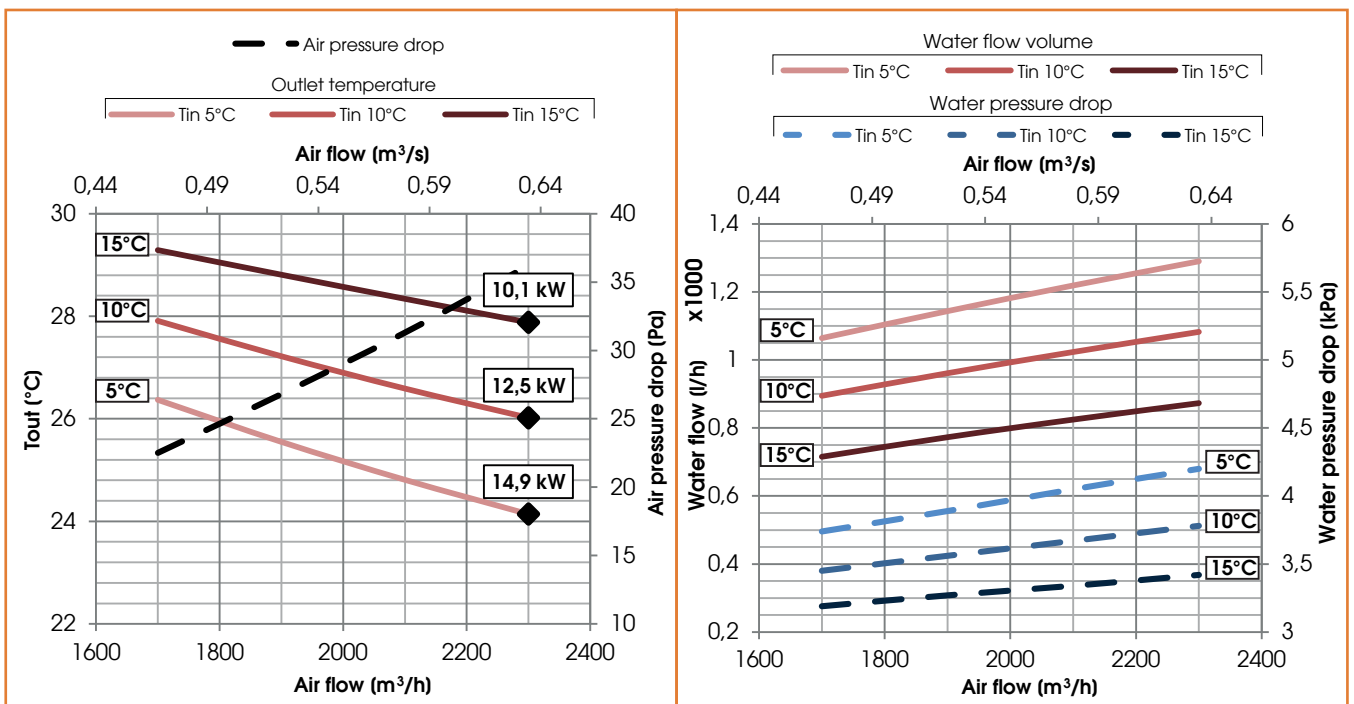



COILS CRHE-V 3200/ENT
Cooling water coil (7°C/12°C)

| Ø WATER ("gas) | N. ROWS | FIN PITCH (mm) | INT.VOL. (dm³) | MATERIALS | | |
|----------------|---------|----------------|----------------|-----------|------|-------|
| | | | | TUBES | FINS | FRAME |
| 1" | 3 | 2,5 | 7 | Cu | Al | Fe Zn |

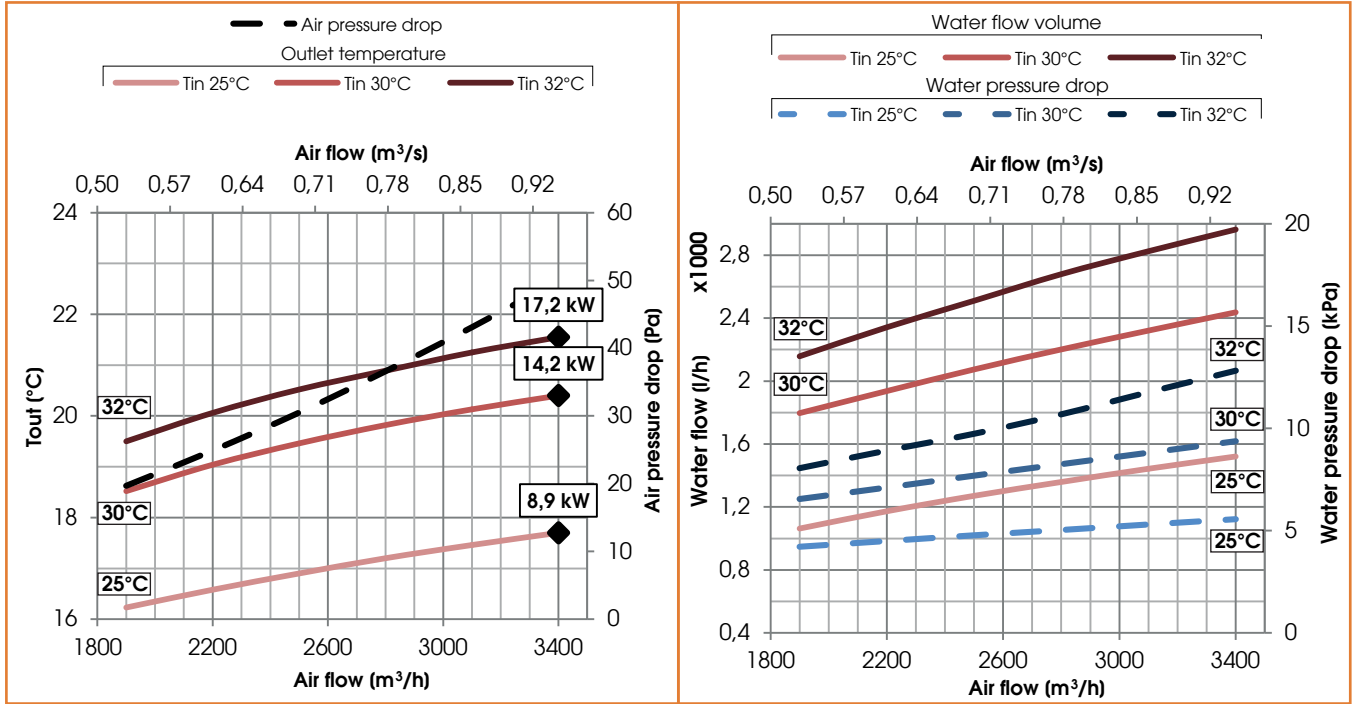

Heating water coil (45°C/35°C)

| Ø WATER ("gas) | N. ROWS | FIN PITCH (mm) | INT.VOL. (dm³) | MATERIALS | | |
|----------------|---------|----------------|----------------|-----------|------|-------|
| | | | | TUBES | FINS | FRAME |
| 1" | 3 | 2,5 | 7 | Cu | Al | Fe Zn |

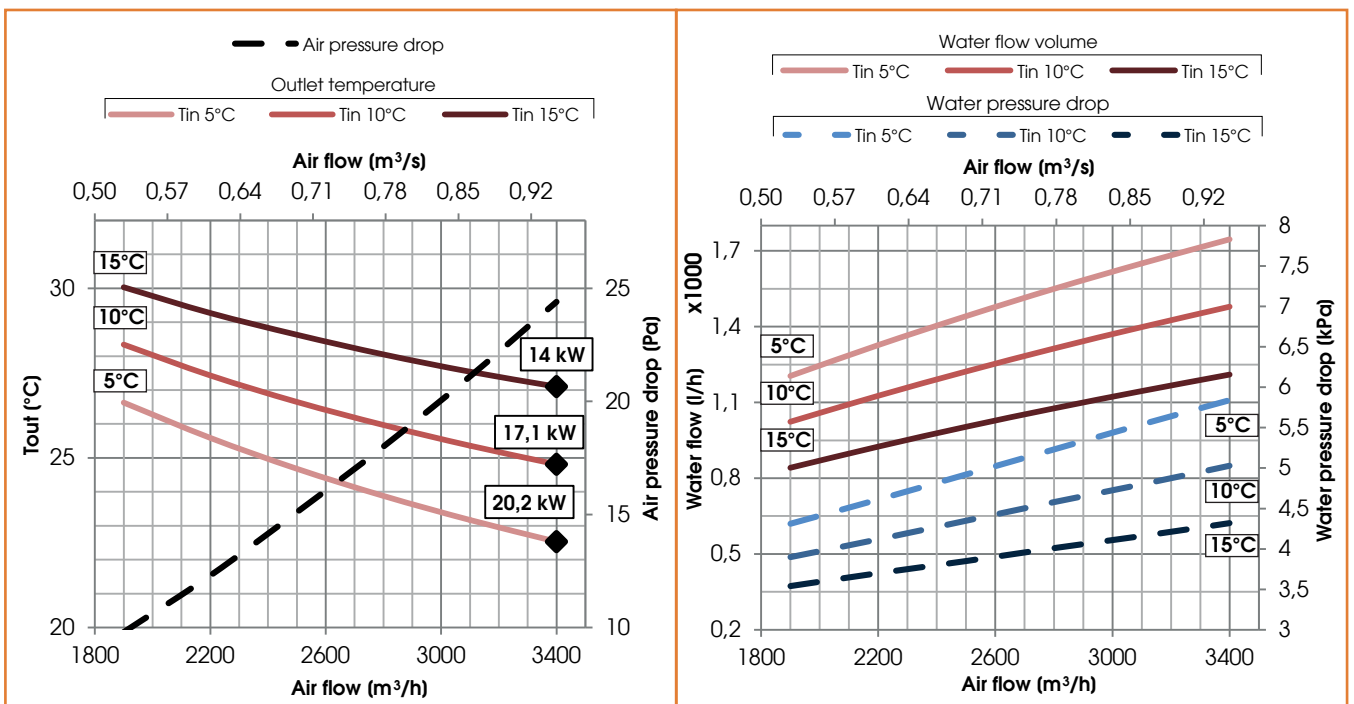



COILS CRHE-V 4500/ENT Cooling water coil (7°C/12°C)

| Ø WATER ("gas) | N. ROWS | FIN PITCH (mm) | INT.VOL. (dm³) | MATERIALS | | |
|----------------|---------|----------------|----------------|-----------|------|-------|
| | | | | TUBES | FINS | FRAME |
| 1" | 3 | 2,5 | 8 | Cu | Al | Fe Zn |

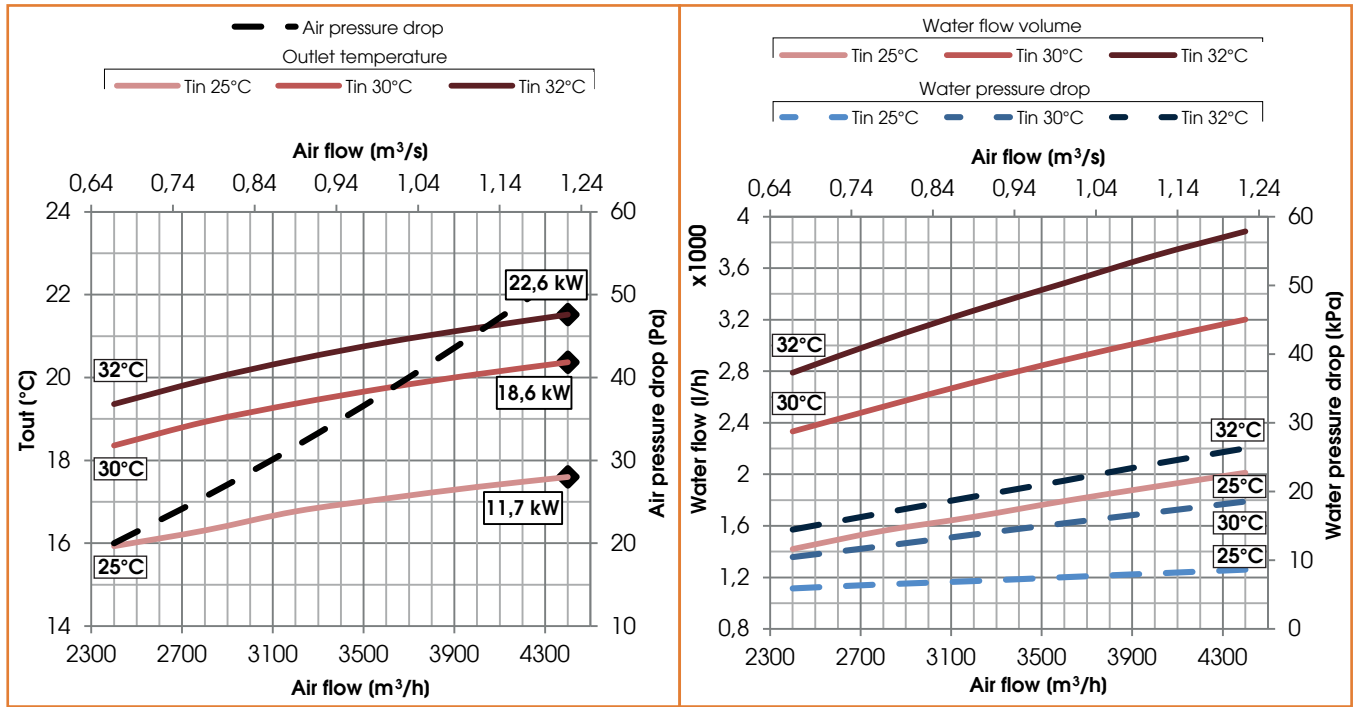

Heating water coil (45°C/35°C)

| Ø WATER ("gas) | N. ROWS | FIN PITCH (mm) | INT.VOL. (dm³) | MATERIALS | | |
|----------------|---------|----------------|----------------|-----------|------|-------|
| | | | | TUBES | FINS | FRAME |
| 1" | 3 | 2,5 | 8 | Cu | Al | Fe Zn |

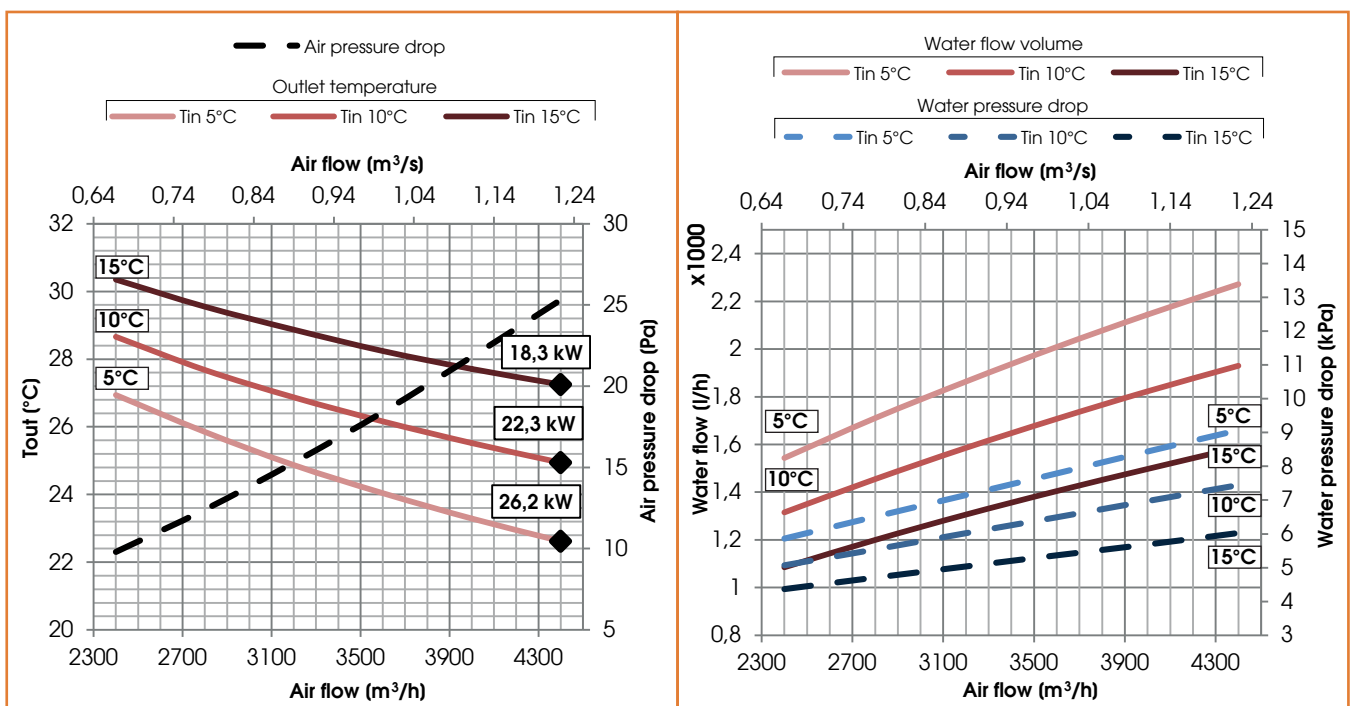



COILS CRHE-V 5600/ENT
Cooling water coil (7°C/12°C)

| Ø WATER ("gas) | N. ROWS | FIN PITCH (mm) | INT.VOL. (dm³) | MATERIALS | | |
|----------------|---------|----------------|----------------|-----------|------|-------|
| | | | | TUBES | FINS | FRAME |
| 1"1/4 | 3 | 2,5 | 12 | Cu | Al | Fe Zn |

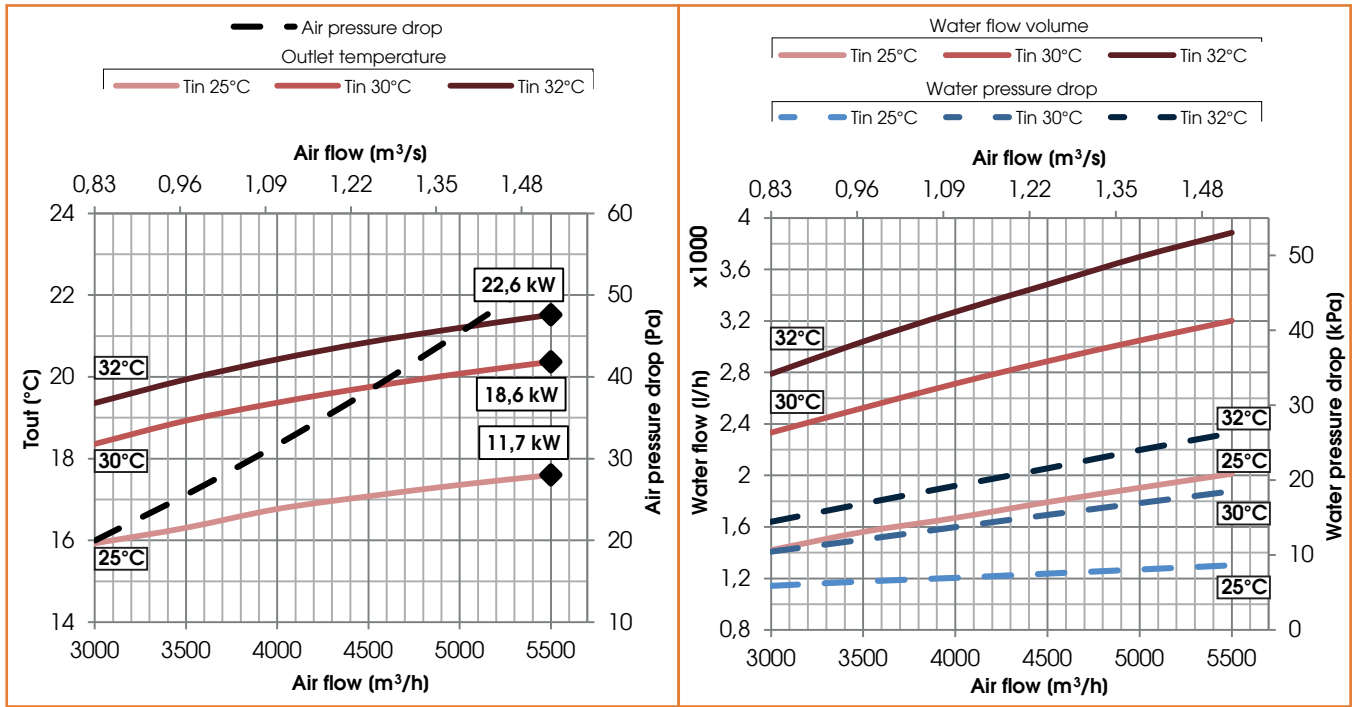

Heating water coil (45°C/35°C)

| Ø WATER ("gas) | N. ROWS | FIN PITCH (mm) | INT.VOL. (dm³) | MATERIALS | | |
|----------------|---------|----------------|----------------|-----------|------|-------|
| | | | | TUBES | FINS | FRAME |
| 1"1/4 | 3 | 2,5 | 12 | Cu | Al | Fe Zn |

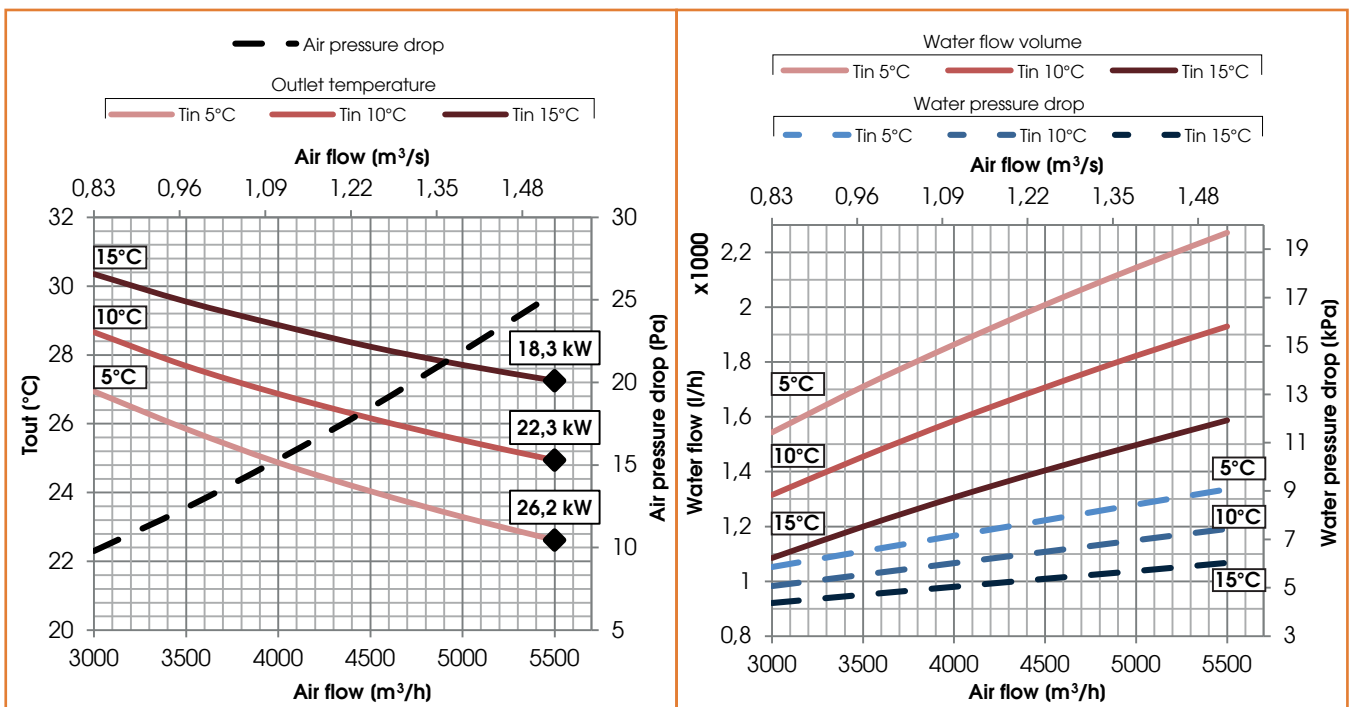



DX coil CRHE-V 700/ENT

| DIRECT EXPANSION COIL (R410A) TECHNICAL DATA | | | | | | |
|--|----------------|------------|----------------|-------------|--------------|------------------------|
| Air flow (m³/h) | Tin (C°) | R.H in (%) | Power (kW) | Tout (°C) | R.H: out (%) | Air pressure drop (Pa) |
| 700 | 28 | 68 | 4,8 | 18 | 91 | 60 |
| Ø Connection (mm) | Fin pitch (mm) | N. Rows | Int.Vol. (dm³) | T evap (°C) | T cond (°C) | |
| 22-12 | 4,0 | 4 | 2 | 5 | 50 | |

DX coil CRHE-V 1100/ENT

| DIRECT EXPANSION COIL (R410A) TECHNICAL DATA | | | | | | |
|--|----------------|------------|----------------|-------------|--------------|------------------------|
| Air flow (m³/h) | Tin (C°) | R.H in (%) | Power (kW) | Tout (°C) | R.H: out (%) | Air pressure drop (Pa) |
| 1100 | 28 | 28 | 8 | 18 | 92 | 47 |
| Ø Connection (mm) | Fin pitch (mm) | N. Rows | Int.Vol. (dm³) | T evap (°C) | T cond (°C) | |
| 22-12 | 4,0 | 4 | 3 | 5 | 50 | |

DX coil CRHE-V 1600/ENT

| DIRECT EXPANSION COIL (R410A) TECHNICAL DATA | | | | | | |
|--|----------------|------------|----------------|-------------|--------------|------------------------|
| Air flow (m³/h) | Tin (C°) | R.H in (%) | Power (kW) | Tout (°C) | R.H: out (%) | Air pressure drop (Pa) |
| 1600 | 28 | 68 | 14 | 15 | 100 | 44 |
| Ø Connection (mm) | Fin pitch (mm) | N. Rows | Int.Vol. (dm³) | T evap (°C) | T cond (°C) | |
| 28-12 | 2,5 | 3 | 3 | 5 | 50 | |

DX coil CRHE-V 2500/ENT

| DIRECT EXPANSION COIL (R410A) TECHNICAL DATA | | | | | | |
|--|----------------|------------|----------------|-------------|--------------|------------------------|
| Air flow (m³/h) | Tin (C°) | R.H in (%) | Power (kW) | Tout (°C) | R.H: out (%) | Air pressure drop (Pa) |
| 2500 | 28 | 68 | 17 | 19 | 94 | 70 |
| Ø Connection (mm) | Fin pitch (mm) | N. Rows | Int.Vol. (dm³) | T evap (°C) | T cond (°C) | |
| 28-28 | 2,5 | 3 | 5 | 5 | 50 | |

DX coil CRHE-V 3200/ENT

| DIRECT EXPANSION COIL (R410A) TECHNICAL DATA | | | | | | |
|--|----------------|------------|----------------|-------------|--------------|------------------------|
| Air flow (m³/h) | Tin (C°) | R.H in (%) | Power (kW) | Tout (°C) | R.H: out (%) | Air pressure drop (Pa) |
| 3200 | 28 | 68 | 22 | 19 | 94 | 60 |
| Ø Connection (mm) | Fin pitch (mm) | N. Rows | Int.Vol. (dm³) | T evap (°C) | T cond (°C) | |
| 28-22 | 2,5 | 3 | 6 | 5 | 50 | |

DX coil CRHE-V 4500/ENT

| DIRECT EXPANSION COIL (R410A) TECHNICAL DATA | | | | | | |
|--|----------------|------------|----------------|-------------|--------------|------------------------|
| Air flow (m³/h) | Tin (C°) | R.H in (%) | Power (kW) | Tout (°C) | R.H: out (%) | Air pressure drop (Pa) |
| 4500 | 28 | 68 | 35 | 18 | 92 | 101 |
| Ø Connection (mm) | Fin pitch (mm) | N. Rows | Int.Vol. (dm³) | T evap (°C) | T cond (°C) | |
| 42-28 | 2,5 | 4 | 10 | 5 | 50 | |

DX coil CRHE-V 5600/ENT

| DIRECT EXPANSION COIL (R410A) TECHNICAL DATA | | | | | | |
|--|----------------|------------|----------------|-------------|--------------|------------------------|
| Air flow (m³/h) | Tin (C°) | R.H in (%) | Power (kW) | Tout (°C) | R.H: out (%) | Air pressure drop (Pa) |
| 5600 | 29 | 70 | 44 | 18,5 | 95 | 51 |
| Ø Connection (mm) | Fin pitch (mm) | N. Rows | Int.Vol. (dm³) | T evap (°C) | T cond (°C) | |
| 42-35 | 2,5 | 3 | 11 | 5 | 50 | |

Electrical heater

| PRE-POST ELECTRICAL HEATER TECHNICAL DATA | | | | |
|---|---------------|------------|-------------|-----------|
| Unit | Power supply | Power (kW) | Current (A) | N. stages |
| CRHE-V 700/ENT | 230V, 50Hz,1F | 2 | 8,7 | 1 |
| CRHE-V 1100/ENT | 230V, 50Hz,1F | 3 | 13,0 | 1 |
| CRHE-V 1600/ENT | 230V, 50Hz,1F | 6 | 26,1 | 1 |
| CRHE-V 2500/ENT | 230V, 50Hz,1F | 6 | 26,0 | 1 |
| CRHE-V 3200/ENT* | 230V, 50Hz,1F | 8 | 34,7 | 1 |
| CRHE-V 3200/ENT | 400V, 50Hz,3F | 8 | 11,5 | 1 |
| CRHE-V 4500/ENT | 400V, 50Hz,3F | 12 | 17,3 | 1 |
| CRHE-V 5600/ENT | 400V, 50Hz,3F | 16 | 23,0 | 1 |

*Pre-heating batteries are always Tri-phase. For other batteries PRE or POST treatment see the Techno-list of ACCESSORIES

| | | | | | |
|---|--|---|---------------------------------|---------------------------------|---------------------------------|
| A | Manufacturer's name | C.L.A. S.r.l. | | | |
| B | Manufacturer's model identifier | CRHE 700EC BP EVO-PH SV | CRHE 1100EC BP EVO-PH SV | CRHE 1600EC BP EVO-PH SV | CRHE 2500EC BP EVO-PH SV |
| C | Declared typology | UVNR / UVB | UVNR / UVB | UVNR / UVB | UVNR / UVB |
| D | Type of drive installed | Variable speed drive | Variable speed drive | Variable speed drive | Variable speed drive |
| E | Type of HRS | other | other | other | other |
| F | Thermal efficiency of heat recovery (%) | 82,2 | 82,2 | 82,7 | 84,6 |
| G | Nominal NRVU flow rate (m³/s) | 0,161 | 0,254 | 0,47 | 0,597 |
| H | Effective electric power input (kW) | 0,29 | 0,33 | 0,95 | 0,82 |
| I | SFPint (W/(m³/s)) | 842 | 461 | 1103 | 569 |
| J | Face velocity at design flow rate (m/s) | 1,2 | 1,3 | 1,5 | 1,5 |
| K | Nominal external pressure (Pa) | 200 | 200 | 200 | 200 |
| L | Internal pressure drop of ventilation components (Pa) | 475 | 278 | 697 | 344 |
| M | Optional: internal pressure drop of non-ventilation components | - | - | - | - |
| N | Static efficiency of fans used in accordance with Regulation (EU) No 327/2011 (%) | 56,5 | 58,5 | 63,2 | 55,4 |
| O | Declared maximum external leakage rate of the casing of ventilation units (%) | 5,4 | 4,6 | 2,9 | 4,0 |
| O | Declared maximum internal leakage rate of bidirectional ventilation units or carry over (for regenerative heat exchangers only) (%) | 9,5 | 7,1 | 4,5 | 4,6 |
| P | Energy performance, preferably energy classification, of the filters (declared information about the calculated annual energy consumption) | ePM1 70% (F7) ePM10 50% (M5) | ePM1 70% (F7) ePM10 50% (M5) | ePM1 70% (F7) ePM10 50% (M5) | ePM1 70% (F7) ePM10 50% (M5) |
| Q | Position and description of visual filter warning for RVUs intended for use with filters, including text pointing out the importance of regular filter changes for performance and energy efficiency of the unit | Filter warning is signalled on the display of the control system: the flashing writing "DirtyFilters" will appear. "To preserve the energy efficiency of the NRVU, it's recommended to replace the filters when signaled." Positioned near the filters inspection | | | |
| R | Casing sound power level (LWA) (dB) | 52 | 51 | 59 | 60 |
| S | Internet address for pre-/dis-assembly instructions | www.utek.it | | | |

| A | Manufacturer's name | C.L.A. S.r.l. | CRHE 3200EC BP EVO-PH SV UVNR / UVB | CRHE 4500EC BP EVO-PH SV UVNR / UVB | CRHE 5600EC BP EVO-PH SV UVNR / UVB | CRHE 700EC BP EVO-PH SV - ENTHALPIC VERSION - UVNR / UVB |
|---|--|---------------|--|--|--|--|
| B | Manufacturer's model identifier | | | | | |
| C | Declared typology | | UVNR / UVB | UVNR / UVB | UVNR / UVB | UVNR / UVB |
| D | Type of drive installed | | Velocità variabile | Velocità variabile | Velocità variabile | Variable speed drive |
| E | Type of HRS | | altro | altro | altro | other |
| F | Thermal efficiency of heat recovery (%) | | 85,0 | 84,9 | 85,6 | 74,4 |
| G | Nominal NRVU flow rate (m³/s) | | 0,825 | 1,129 | 1,453 | 0,16 |
| H | Effective electric power input (kW) | | 1,47 | 2,59 | 2,88 | 0,28 |
| I | SFPint (W/(m³/s)) | | 695 | 1040 | 781 | 872 |
| J | Face velocity at design flow rate (m/s) | | 1,5 | 2,0 | 1,8 | 1,17 |
| K | Nominal external pressure (Pa) | | 200 | 250 | 250 | 200 |
| L | Internal pressure drop of ventilation components (Pa) | | 299 | 480 | 370 | 488 |
| M | Optional: internal pressure drop of non-ventilation components | | - | - | - | - |
| N | Static efficiency of fans used in accordance with Regulation (EU) No 327/2011 (%) | | 48,3 | 51,4 | 54,0 | 55,8 |
| O | Declared maximum external leakage rate of the casing of ventilation units (%) | | 4,2 | 3,6 | 3,0 | 5,5 |
| O | Declared maximum internal leakage rate of bidirectional ventilation units or carry over (for regenerative heat exchangers only) (%) | | 3,5 | 2,8 | 2,3 | 9,8 |
| P | Energy performance, preferably energy classification, of the filters (declared information about the calculated annual energy consumption) | | ePM1 70% (F7) ePM10 50% (M5) | ePM1 70% (F7) ePM10 50% (M5) | ePM1 70% (F7) ePM10 50% (M5) | ePM1 70% (F7) ePM10 50% (M5) |
| Q | Position and description of visual filter warning for RVUs intended for use with filters, including text pointing out the importance of regular filter changes for performance and energy efficiency of the unit | | Filter warning is signaled on the display of the control system: the flashing writing "DirtyFilters" will appear. "To preserve the energy efficiency of the NRVU, it's recommended to replace the filters when signaled." Positioned near the filters inspection | | | |
| R | Casing sound power level (LWA) (dB) | | 63 | 68 | 73 | 52 |
| S | Internet address for pre-/dis-assembly instructions | | www.utek.it | | | |

| | | | | | | |
|---|--|--|--|--|--|--|
| A | Manufacturer's name | C.L.A. S.r.l. | CRHE 1100EC BP EVO-PH SV - ENTHALPIC VERSION- | CRHE 1600EC BP EVO-PH SV - ENTHALPIC VERSION- | CRHE 2500EC BP EVO-PH SV - ENTHALPIC VERSION- | CRHE 3200EC BP EVO-PH SV - ENTHALPIC VERSION- |
| B | Manufacturer's model identifier | | | | | |
| C | Declared typology | UVNR / UVB | UVNR / UVB | UVNR / UVB | UVNR / UVB | UVNR / UVB |
| D | Type of drive installed | Variable speed drive | Variable speed drive | Variable speed drive | Variable speed drive | Variable speed drive |
| E | | other | other | other | other | other |
| F | Thermal efficiency of heat recovery (%) | 76,5 | 82,7 | 77,6 | 78,3 | |
| G | Nominal NRVU flow rate (m³/s) | 0,24 | 0,47 | 0,58 | 0,81 | |
| H | Effective electric power input (kW) | 0,32 | 0,95 | 0,81 | 1,47 | |
| I | SFPint (W/(m³/s)) | 544 | 1103 | 691 | 754 | |
| J | Face velocity at design flow rate (m/s) | 1,25 | 1,56 | 1,4 | 1,4 | |
| K | Nominal external pressure (Pa) | 200 | 200 | 200 | 200 | |
| L | Internal pressure drop of ventilation components (Pa) | 321 | 697 | 399 | 336 | |
| M | Optional: internal pressure drop of non-ventilation components | - | - | - | - | |
| N | Static efficiency of fans used in accordance with Regulation (EU) No 327/2011 (%) | 59,0 | 63,2 | 57,8 | 49,1 | |
| | Declared maximum external leakage rate of the casing of ventilation units (%) | 4,8 | 2,9 | 4,1 | 4,2 | |
| O | Declared maximum internal leakage rate of bidirectional ventilation units or carry over (for regenerative heat exchangers only) (%) | 7,4 | 4,5 | 4,7 | 3,6 | |
| P | Energy performance, preferably energy classification, of the filters (declared information about the calculated annual energy consumption | ePM1 70% (F7) ePM10 50% (M5) | ePM1 70% (F7) ePM10 50% (M5) | ePM1 70% (F7) ePM10 50% (M5) | ePM1 70% (F7) ePM10 50% (M5) | |
| Q | Position and description of visual filter warning for RVUs intended for use with filters, including text pointing out the importance of regular filter changes for performance and energy efficiency of the unit | Filter warning is signaled on the display of the control system: the flashing writing "DirtyFilters" will appear. "To preserve the energy efficiency of the NRVU, it's recommended to replace the filters when signaled." Positioned near the filters inspection | | | | |
| R | Casing sound power level (LWA) (dB) | 51 | 59 | 60 | 63 | |
| S | Internet address for pre-/dis-assembly instructions | www.utek.it | | | | |

| | | | | |
|---|--|---------------|--|--|
| A | Manufacturer's name | C.L.A. S.r.l. | CRHE 4500EC BP EVO-PH SV - ENTHALPIC VERSION- | CRHE 5600EC BP EVO-PH SV - ENTHALPIC VERSION- |
| B | Manufacturer's model identifier | | UVNR / UVB | UVNR / UVB |
| C | Declared typology | | Variable speed drive | Variable speed drive |
| D | Type of drive installed | | other | other |
| E | | | | |
| F | Thermal efficiency of heat recovery (%) | | 76,7 | 77,5 |
| G | Nominal NRJU flow rate (m³/s) | | 1,03 | 1,44 |
| H | Effective electric power input (kW) | | 2,62 | 2,88 |
| I | SFPint (W/(m³/s)) | | 1009 | 815 |
| J | Face velocity at design flow rate (m/s) | | 1,2 | 1,8 |
| K | Nominal external pressure (Pa) | | 350 | 250 |
| L | Internal pressure drop of ventilation components (Pa) | | 523 | 390 |
| M | Optional: internal pressure drop of non-ventilation components | | - | - |
| N | Static efficiency of fans used in accordance with Regulation (EU) No 327/2011 (%) | | 56,1 | 54,7 |
| | Declared maximum external leakage rate of the casing of ventilation units (%) | | 3,9 | 3,0 |
| O | Declared maximum internal leakage rate of bidirectional ventilation units or carry over (for regenerative heat exchangers only) (%) | | 3,0 | 2,3 |
| P | Energy performance, preferably energy classification, of the filters (declared information about the calculated annual energy consumption) | | ePM1 70% (F7) ePM10 50% (M5) | ePM1 70% (F7) ePM10 50% (M5) |
| Q | Position and description of visual filter warning for RVUs intended for use with filters, including text pointing out the importance of regular filter changes for performance and energy efficiency of the unit | | Filter warning is signaled on the display of the control system; the flashing writing "DirtyFilters" will appear. "To preserve the energy efficiency of the NRJU, it's recommended to replace the filters when signaled." Positioned near the filters inspection | |
| R | Casing sound power level (LWA) (dB) | | 68 | 73 |
| S | Internet address for pre-/dis-assembly instructions | | www.utek.it | |

CLA & UTEK reserves the right to at any time the necessary changes to improve products without prior notice .

Dear Customer

Thanks for your attention to the product UTEK , designed and manufactured to ensure the real values to the User : Quality, Safety and Savings on working.



Made in Italy

**AZIENDA CON SISTEMA
DI GESTIONE QUALITÀ
CERTIFICATO DA DNV GL
ISO 9001**

**AZIENDA CON
SISTEMA DI GESTIONE
AMBIENTALE CERTIFICATO
DA DNV
ISO 14001**



the Dealer

CRHE-V_2018_2_EN



VENTILATION UNIT WITH HEAT RECOVERY FOR COMMERCIAL AND INDUSTRIAL BUILDINGS