



indoor air quality and energy saving

TECHNICAL DATA



CRHE-H & CRHE-H ENT



VENTILATION UNIT WITH HEAT RECOVERY FOR COMMERCIAL AND INDUSTRIAL BUILDINGS



CRHE-H

Non-residential ventilator unit with dual flow and high yield heat recovery. From size 1100 to 3400 it's possible to have also the version with enthalpic heat exchanger

PERFORMANCE

Equipped with counter current heat exchanger in aluminium (Eurovent certified) and electronic backward blade ventilators. The total bypass as standard allows favourable climatic conditions to be taken advantage of outside the building for free cooling (or free heating) in automatic mode.

STRUCTURE

CRHE-H is manufactured using a profiled extruded aluminium frame and 25 mm thick sandwich panels, insulated in polyurethane foam. The panels and inner parts are manufactured in Aluzinc[®] material that ensures high strength against corrosion and oxidation. A panel with shutter opening eases access to the filters (ePM1 70% (F7) for the renewed air flow and ePM10 50% (M5) for the extraction air flow). CRHE H is prepared for installation outdoors (with an optional, specific protective roof) and indoors. Available in 5 sizes, it can be equipped with air post-treatment systems (inside the unit) such as: hot/cold water battery, electrical heater or direct expansion battery. CRHE-H was designed to enable easy configuration of the connection to the air distribution/captation ducts. It is also possible and easy to install post-air treatment devices after sale.

CONTROLS

CRHE H was supplied with an electric box and control system; it is available in a version equipped with EVO-PH control and a version equipped with EVOD-PH-IP control prepared for complete integration in home automation systems (Modbus protocol with Ethernet connection or, on request, with the addition of connection RS485). The new version of our control systems enables extremely easy and rapid passage from a control system to another, even after installation with the single replacement of the remote panel.

The EVO-PH control has a coloured, backlit touch screen interface with intuitive viewing of the working status of the machine. It enables precise adjustment of ventilator speed and has a weekly , time schedule for automatic management of the ventilators. It can be controlled by an external switch to activate the booster function, it can automatically adjust the air flow rate if connected to an air quality probe, it can manage any air post treatment accessories, it automatically manages the bypass and prevents heat exchanger freezing by managing the speed of the ventilators or, if installed, an electrical pre-heating resistor (optional accessory outside the machine); it signals to the user the need to replace the filters (the clogging status of the filters is monitored by a pair of different pressure switches, supplied as standard) or an anomaly, indicating the origin. With the addition of optional accessories (COP kit and CAV kit installed on the channel) you can manage the ventilation machine in constant pressure or constant flow rate mode.

The EVOD-PH-IP control has the same characteristics as the EVO-PH version with the addition of Modbus communication protocol which allows full control of the machine by the supervision software of the home automation system. The implemented webserver allows interaction with the machine, even with an internet browser of a device connected (even from remote) to the home automation system in which the machine is inserted.

ACCESSORIES

CRHE-H can be equipped with other accessories such as:

- . R.H. of probe, CO2 or CO2 / VOC
- . Operating kit pressure or constant flow
- . protection roof for outside installazione
- . grilles and damper

For a more complete view of the characteristics of the control panels, please read the specific manuals

CRHE-H (horizontal) - TOP VIEW

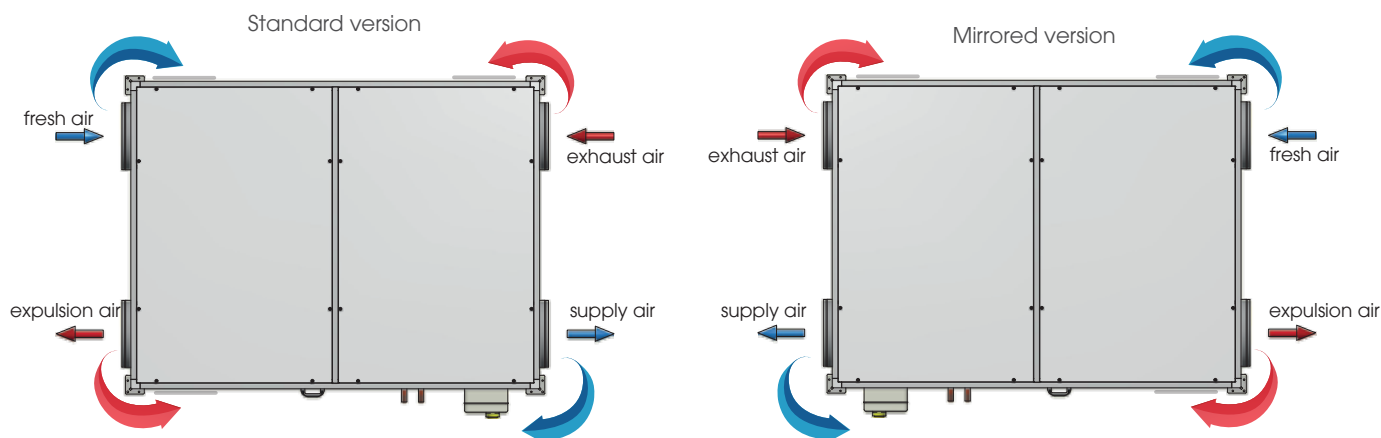

Counterflow heat exchanger made of aluminum manufactured by RECUTECH
RECUTECH participates in the Eurovent Certification Program

For the enthalpic version: counterflow heat exchanger manufactured by POLYBLOC
POLYBLOC participates in the Eurovent Certification Program



PERFORMANCE (UNI EN 13141-7)

The unit must be ducted properly: UTEK authorizes the use only according to its performance diagram shown into this catalogue
The declared performances are with CLEAN filters, and guaranteed ONLY with the original filters UTEK low pressure drop.

CRHE-H 700

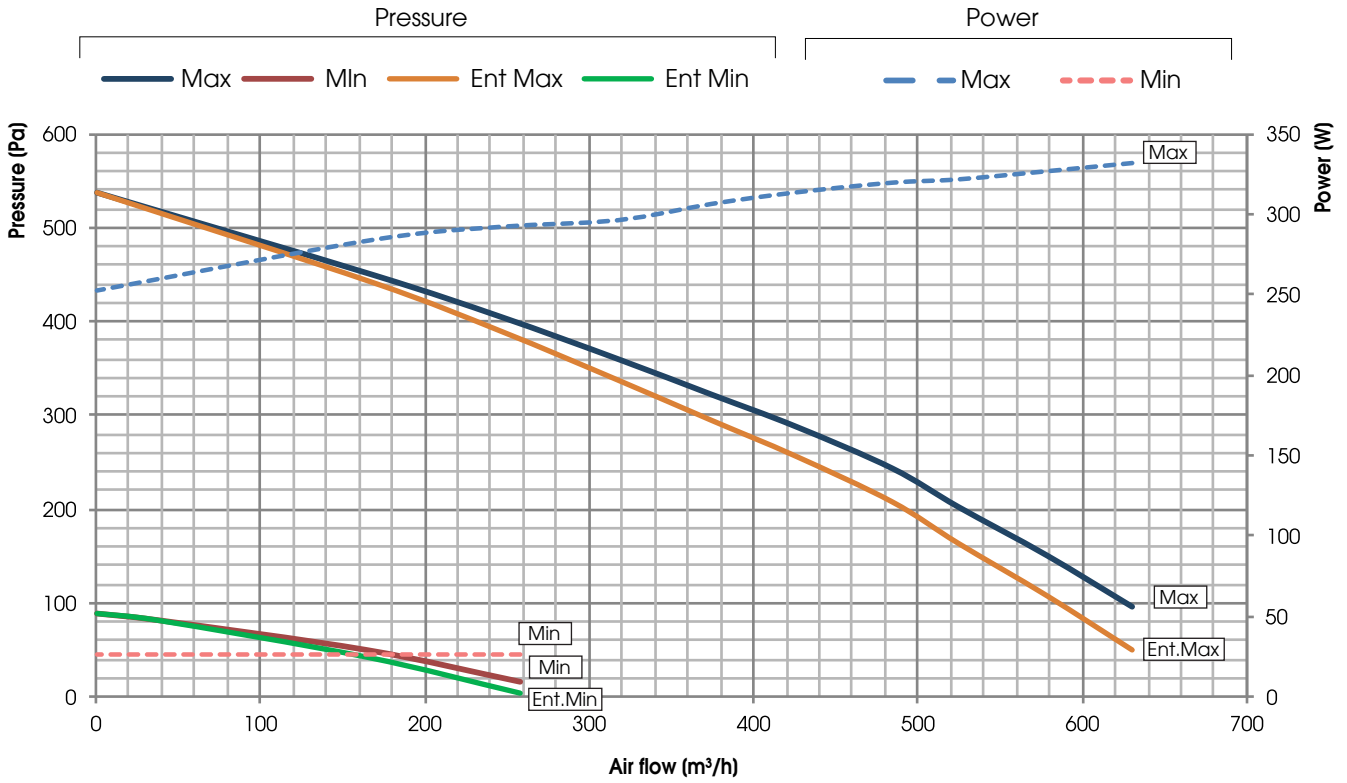

CRHE-H 1100 & CRHE-H 1100 ENT

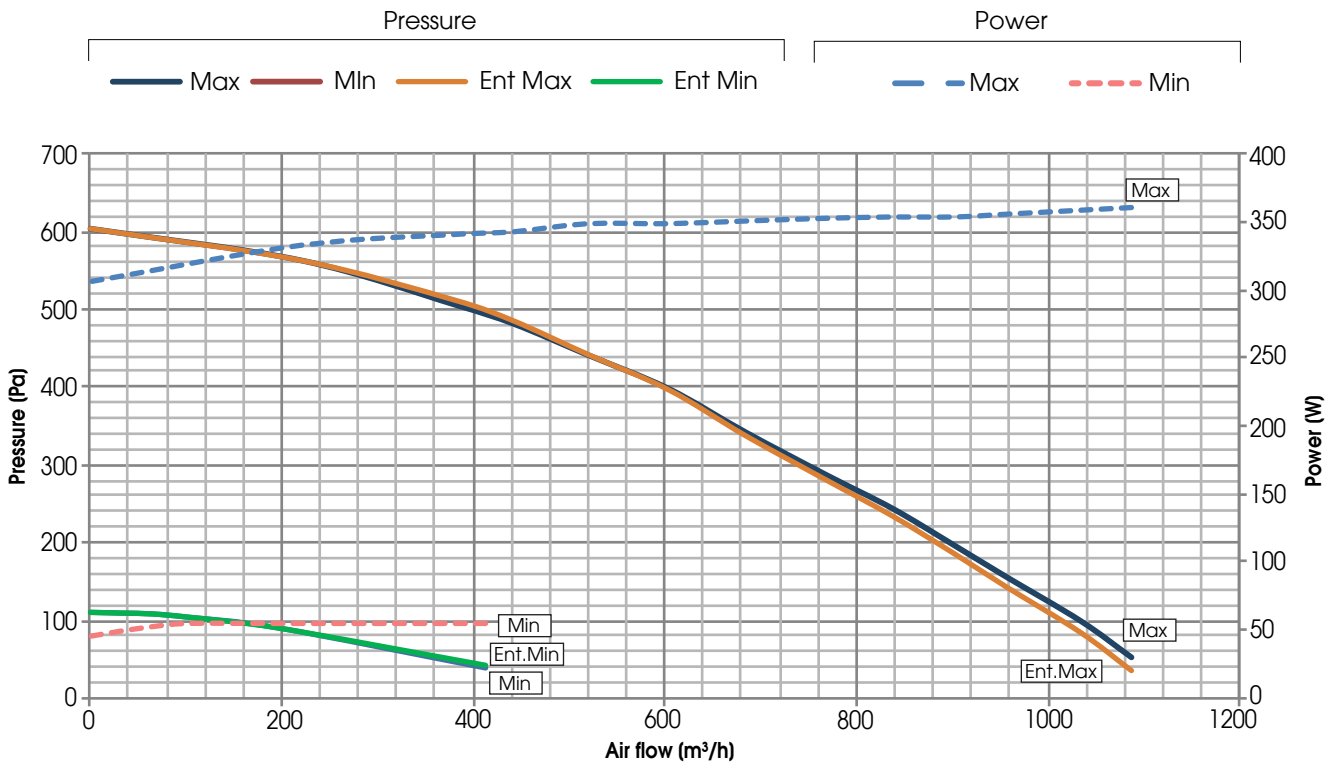



PERFORMANCE (UNI EN 13141-7)

The unit must be ducted properly: UTEK authorizes the use only according to its performance diagram shown into this catalogue
The declared performances are with CLEAN filters, and guaranteed ONLY with the original filters UTEK low pressure drop.

CRHE-H 1600 & CRHE-H 1600 ENT

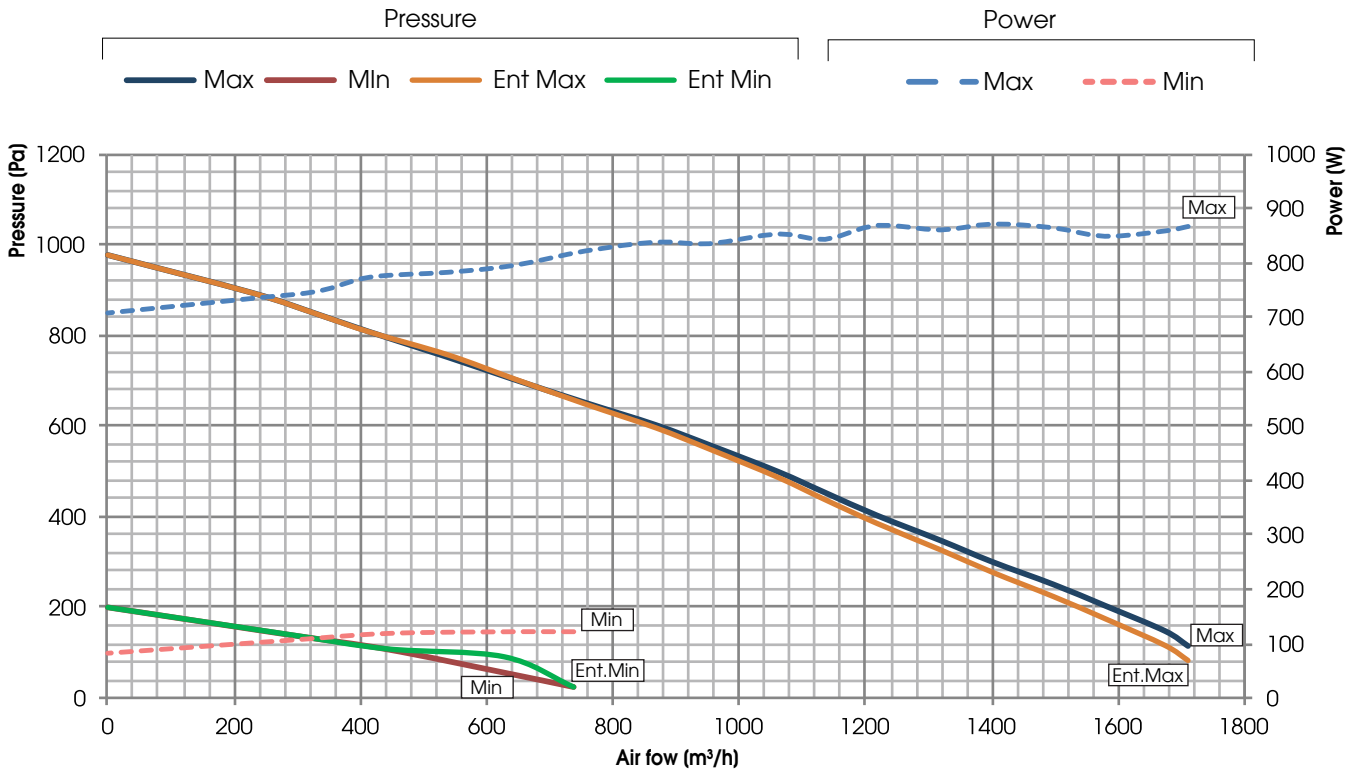

CRHE-H 2300 & CRHE-H 2300 ENT

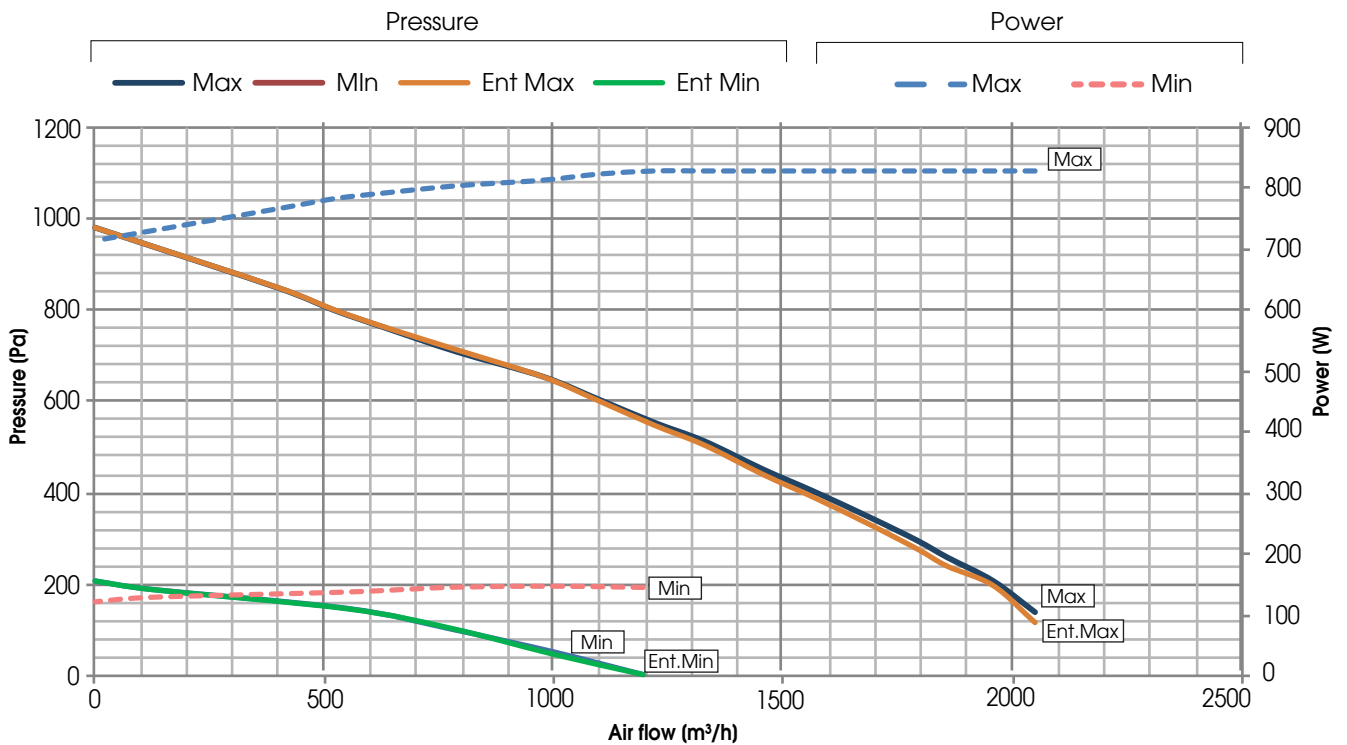



PERFORMANCE (UNI EN 13141-7)

The unit must be ducted properly: UTEK authorizes the use only according to its performance diagram shown into this catalogue
The declared performances are with CLEAN filters, and guaranteed ONLY with the original filters UTEK low pressure drop.

CRHE-H 3400 & CRHE-H 3400 ENT

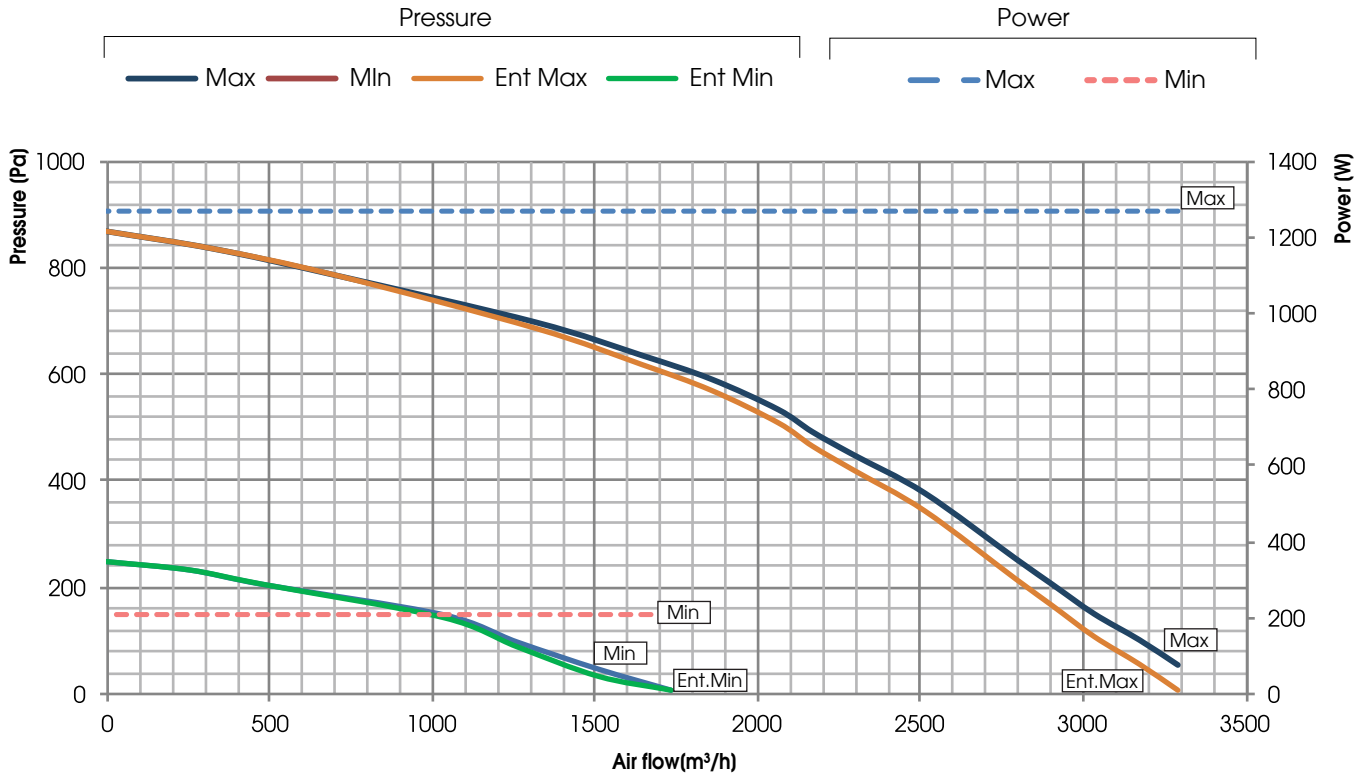

HEAT RECOVERY PERFORMANCE (sensible efficiency)

Values referred to the following conditions (UNI EN 308:1998): T_{bs} external air 5°C; U.R. esternal 72%; T_{bs} enviornment 25°C; U.R. enviornment 38%

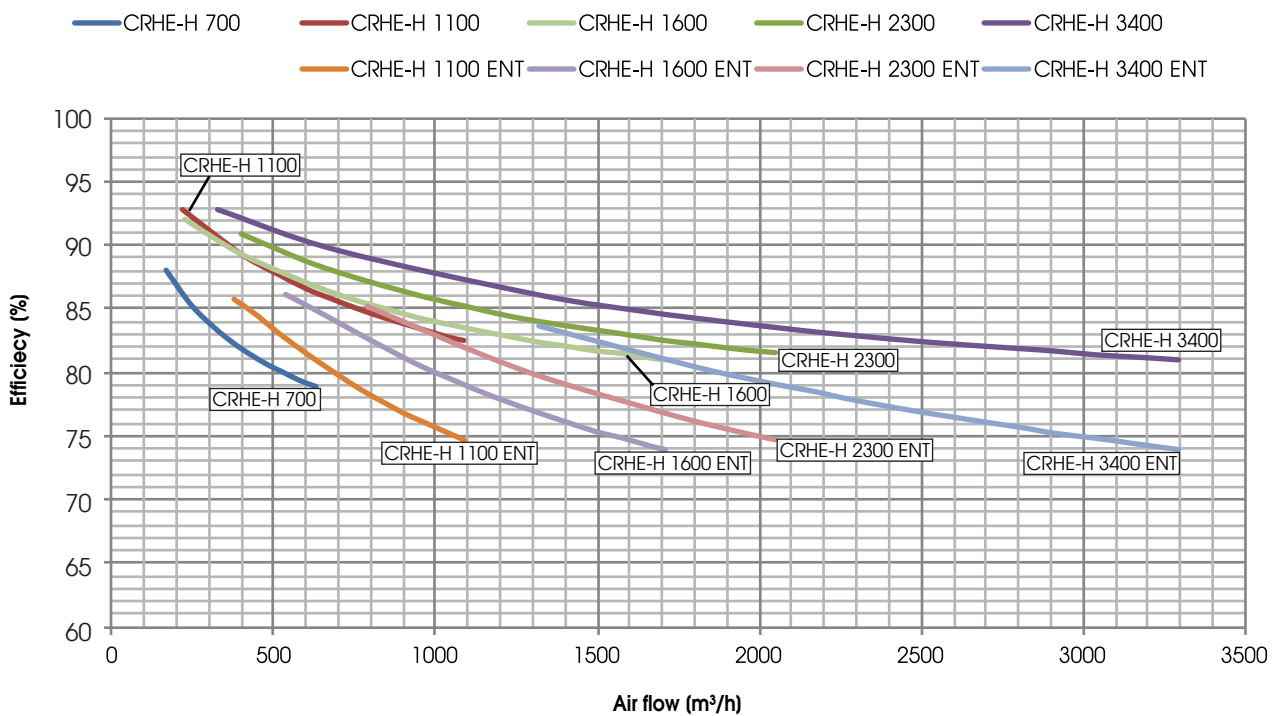



ECODESIGN

MODEL	η_{t_nvr} (%)	q_{nom} (m ³ /s)	$\Delta p_{s,ext}$ (Pa)	P (kW)	SFP _{int} (W/(m ³ /s))	SFP _{int_lim 2016} (W/(m ³ /s))	SFP _{int_lim 2018} (W/(m ³ /s))	FACE VELOCITY (m/s)	$\Delta p_{s,int}$ (Pa)	η_{Fan} (%)	* Internal LEAKAGE (%)	* External LEAKAGE (%)
CRHE-H 700	80,0	0,15	200	0,32	1079	1567	1287	1,87	511	54,4	11,2	5,7
CRHE-H 1100	84,0	0,25	200	0,35	529	1671	1391	1,62	296	58,7	4,4	4,2
CRHE-H 1600	81,7	0,42	250	0,93	1197	1579	1299	1,91	728	62,8	5,4	3,6
CRHE-H 2300	81,8	0,55	200	0,83	753	1561	1281	2,04	498	60,8	4,7	3,2
CRHE-H 3400	81,7	0,81	200	1,27	664	1518	1238	1,97	349	49,7	3,1	2,6

* Compared to q_{nom}

ECODESIGN CRHE ENT

MODEL	η_{t_nvr} (%)	q_{nom} (m ³ /s)	$\Delta p_{s,ext}$ (Pa)	P (kW)	SFP _{int} (W/(m ³ /s))	SFP _{int_lim 2016} (W/(m ³ /s))	SFP _{int_lim 2018} (W/(m ³ /s))	FACE VELOCITY (m/s)	$\Delta p_{s,int}$ (Pa)	η_{Fan} (%)	* Internal LEAKAGE (%)	* External LEAKAGE (%)
CRHE-H 1100/ENT	77,1	0,25	200	0,35	552	1465	1185	1,60	310	59,0	4,4	4,3
CRHE-H 1600/ENT	76,5	0,38	300	0,87	1118	1429	1149	2,46	711	61,8	5,4	3,6
CRHE-H 2300/ENT	75,3	0,54	200	0,83	774	1367	1087	2,02	517	61,2	4,7	3,2
CRHE-H 3400/ENT	75,6	0,79	200	1,27	766	1339	1059	1,91	433	52,5	3,2	2,7

* Compared to q_{nom}

VALUES ACCORDING UNI EN 1886: 2008

UNIT	CASING STRENGTH	CASING LEAKAGE	FILTER CLASS	THERMAL TRANSMITTANCE	THERMAL BRIDGE
CRHE-H 700	D1 (M)	L3 (M)	ePM1 70% (F7) (M)	T4 (M)	TB4 (M)
CRHE-H 1100/ENT	D1 (M)	L3 (M)	ePM1 70% (F7) (M)	T4 (M)	TB4 (M)
CRHE-H 1600/ENT	D1 (M)	L3 (M)	ePM1 70% (F7) (M)	T4 (M)	TB4 (M)
CRHE-H 2300/ENT	D1 (M)	L3 (M)	ePM1 70% (F7) (M)	T4 (M)	TB4 (M)
CRHE-H 3400/ENT	D1 (M)	L3 (M)	ePM1 70% (F7) (M)	T4 (M)	TB4 (M)

TEST LEAKAGE (UNI EN 13141-7)

LEAKAGE	TEST CONDITIONS	LEAKAGE CLASSIFICATION				
		CRHE-H 700	CRHE-H 1100/ENT	CRHE-H 1600/ENT	CRHE-H 2300/ENT	CRHE-H 3400/ENT
OUTDOOR	Positive pressure 400 Pa	A2	A2	A2	A2	A2
OUTDOOR	Negative pressure 400 Pa	A2	A2	A2	A2	A1
INDOOR	Pressure difference 250 Pa	A3	A2	A2	A2	A2

NOISE LEVEL

L_w Sound power level taken in accordance to UNI EN ISO 3747 - CLASS 3

MODEL	NOISE FROM THE CASE (dB)								L_w dB(A)
	125 Hz	250 Hz	500 Hz	1000 Hz	2000 Hz	4000 Hz	8000 Hz		
CRHE-H 700	58	59	46	41	35	30	22	51,8	
CRHE-H 700	NOISE IN THE DUCTS (dB)								L_w dB(A)
	67	68	54	53	51	47	45	61,9	
CRHE-H 1100/ENT	NOISE FROM THE CASE (dB)								L_w dB(A)
	66	66	55	46	41	33	31	59,6	
CRHE-H 1100/ENT	NOISE IN THE DUCTS (dB)								L_w dB(A)
	72	67	58	47	45	37	32	61,6	
CRHE-H 1600/ENT	NOISE FROM THE CASE (dB)								L_w dB(A)
	68	70	55	50	44	36	26	62,8	
CRHE-H 1600/ENT	NOISE IN THE DUCTS (dB)								L_w dB(A)
	73,7	84,5	64,5	60,1	59,9	55,0	45,8	76,4	
CRHE-H 2300/ENT	NOISE FROM THE CASE (dB)								L_w dB(A)
	67	74	60	57	52	44	34	66,8	
CRHE-H 2300/ENT	NOISE IN THE DUCTS (dB)								L_w dB(A)
	69	77	61	60	55	48	39	69,3	
CRHE-H 3400/ENT	NOISE FROM THE CASE (dB)								L_w dB(A)
	69	76	57	59	50	43	35	68,6	
CRHE-H 3400/ENT	NOISE IN THE DUCTS (dB)								L_w dB(A)
	76	78	60	61	56	51	43	70,9	



ELECTRICAL DATA

MATCHING	FANS				UNIT CRHE-H		
	Power (W)	Supply	Current max. (A)	Insulation class	Supply	Current max. (A)	Insulation class
CRHE-H 700	2 x 145	230V 50/60 Hz 1F	2 x 1,20	IP54 CLASS B	230V 50 Hz 1F	2,50	IP 20
CRHE-H 1100/ENT	2 x 170	230V 50/60 Hz 1F	2 x 1,40	IP54 CLASS B	230V 50 Hz 1F	2,90	IP 20
CRHE-H 1600/ENT	2 x 448	230V 50/60 Hz 1F	2 x 2,80	IP54 CLASS B	230V 50 Hz 1F	5,70	IP 20
CRHE-H 2300/ENT	2 x 448	230V 50/60 Hz 1F	2 x 2,80	IP54 CLASS B	230V 50 Hz 1F	5,70	IP 20
CRHE-H 2300/ENT	2 x 448	230V 50/60 Hz 1F	2 x 2,80	IP54 CLASS B	230V 50 Hz 1F	5,70	IP 20
CRHE-H 3400/ENT	2 x 715	230V 50/60 Hz 1F	2 x 3,10	IP54 CLASS B	230V 50 Hz 1F	6,30	IP 20

DIMENSIONS (mm) WEIGHT (kg)

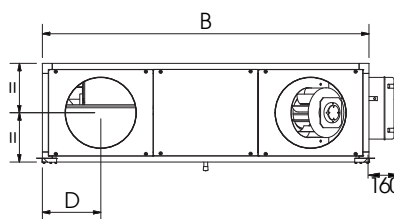
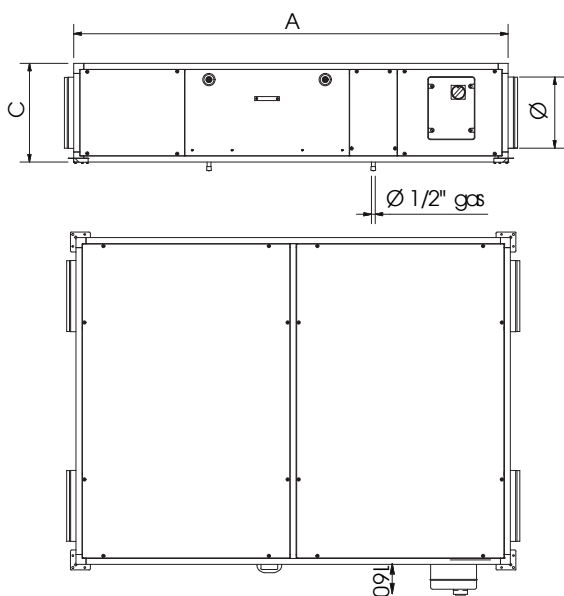

MODEL	Dimensions (mm)					
	A	B	C	D	Ø	Peso(kg)
CRHE-H 700	1590	740	360	200	200	103
CRHE-H 1100/ENT	1815	1240	420	225	250	149
CRHE-H 1600/ENT	2180	1340	495	295	355	203
CRHE-H 2300/ENT	2180	1640	495	295	355	280
CRHE-H 3400/ENT	2400	1740	635	450	450	352

STANDARD SIPHON (mm)

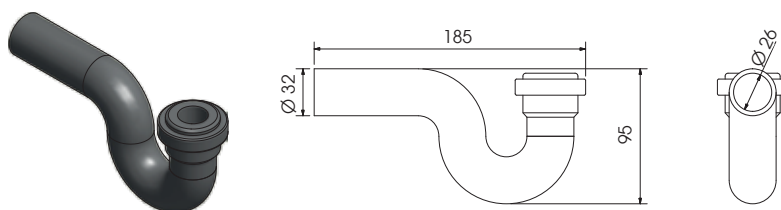

N.B.: prevedere 1 sifone addizionale se è prevista la batteria ad acqua fredda BA-AF/AC o gas DX



INSTALLATION CRHE-H FLOOR INSTALLATION

■ Minimum required space for maintenance (mm)

UNIT	Dimensions (mm)			
	A	B	C	E
CRHE-H 700	660	600	360	340
CRHE-H 1100/ENT	720	600	420	400
CRHE-H 1600/ENT	820	600	495	530
CRHE-H 2300/ENT	820	800	495	530
CRHE-H 3400/ENT	980	850	635	560

UNIT	Dimensions (mm)			
	A	B	C	D
CRHE-H 700	250	700	250	370
CRHE-H 1100/ENT	250	1200	250	430
CRHE-H 1600/ENT	250	1200	320	560
CRHE-H 2300/ENT	250	1600	320	560
CRHE-H 3400/ENT	250	1700	320	590

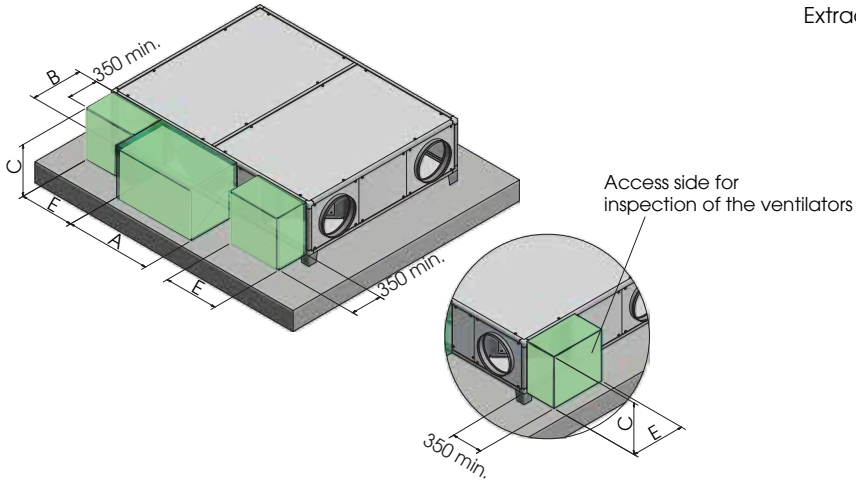

Extraordinary maintenance and replacing of water coil and electric heater

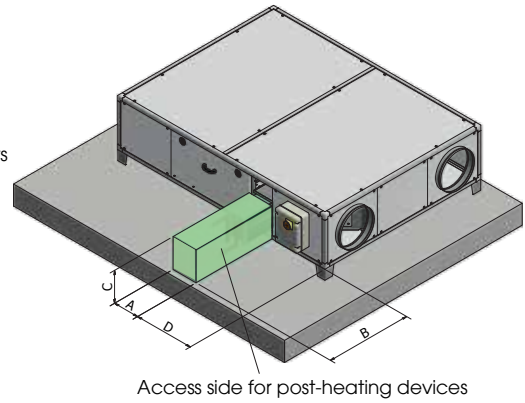

CEILING INSTALLATION

■ Minimum required space for maintenance (mm)

UNIT	Dimensions (mm)			
	A	B	C	E
CRHE-H 700	660	600	360	340
CRHE-H 1100/ENT	720	600	420	400
CRHE-H 1600/ENT	820	600	495	530
CRHE-H 2300/ENT	820	800	495	530
CRHE-H 3400/ENT	980	850	635	560

UNIT	Dimensions (mm)			
	A	B	C	D
CRHE-H 700	250	700	250	370
CRHE-H 1100	250	1200	250	430
CRHE-H 1600	250	1200	320	560
CRHE-H 2300	250	1600	320	560
CRHE-H 3400	250	1700	320	590

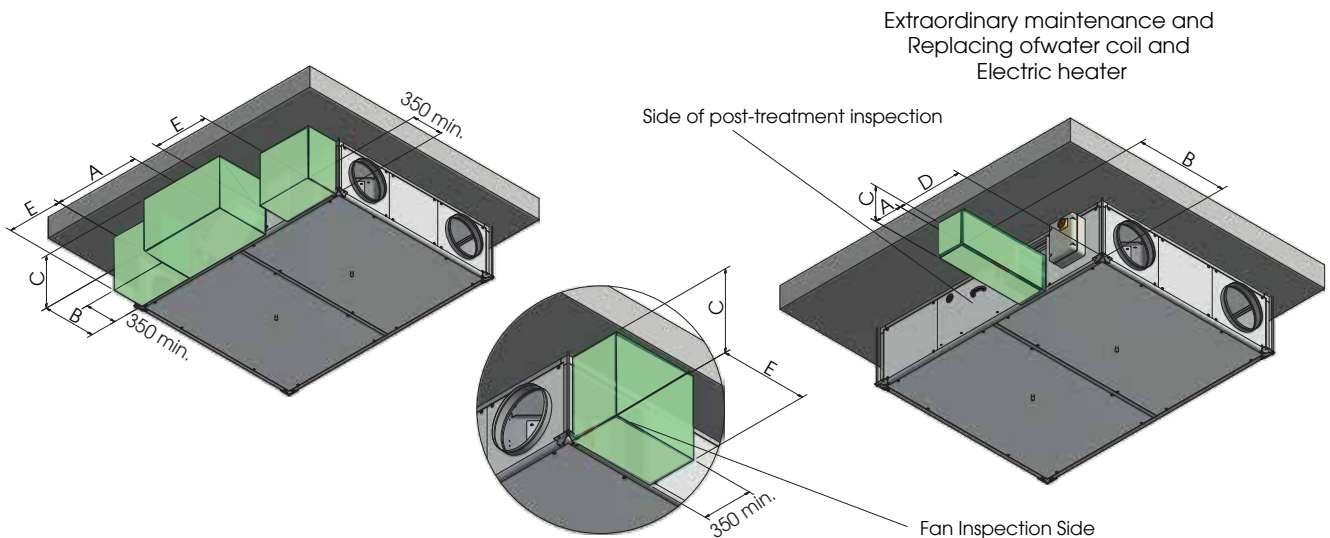

Extraordinary maintenance and
Replacing of water coil and
Electric heater



The way to read the graphs is specified within the accessories technologistino.

COILS CRHE-H 700
Cooling water coil (7°C/12°C)

Ø WATER ("gas)	N. ROWS	FIN PITCH (mm)	INT.VOL. (dm³)	MATERIALS		
				TUBES	FINS	FRAME
1/2"	2	2,5	1	Cu	Al	Fe Zn

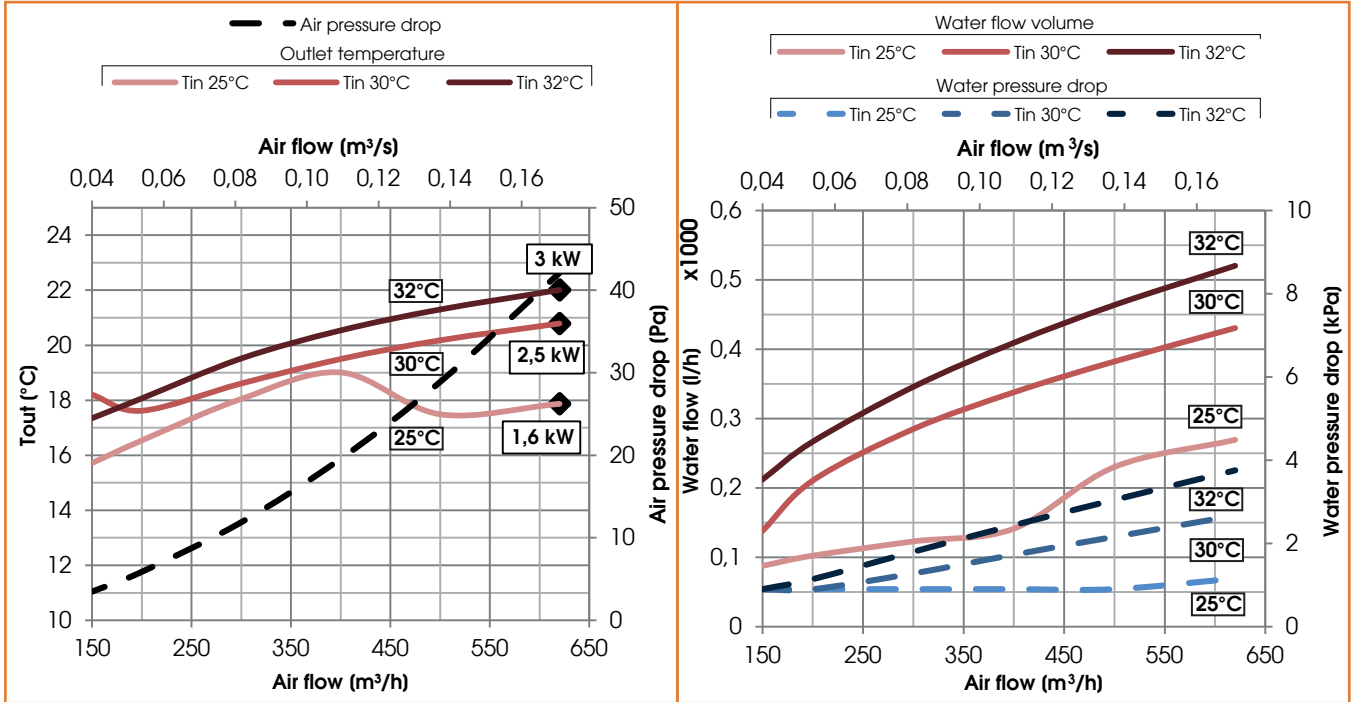

Heating water coil (45°C/35°C)

Ø WATER ("gas)	N. ROWS	FIN PITCH (mm)	INT.VOL. (dm³)	MATERIALS		
				TUBES	FINS	FRAME
1/2"	2	2,5	1	Cu	Al	Fe Zn

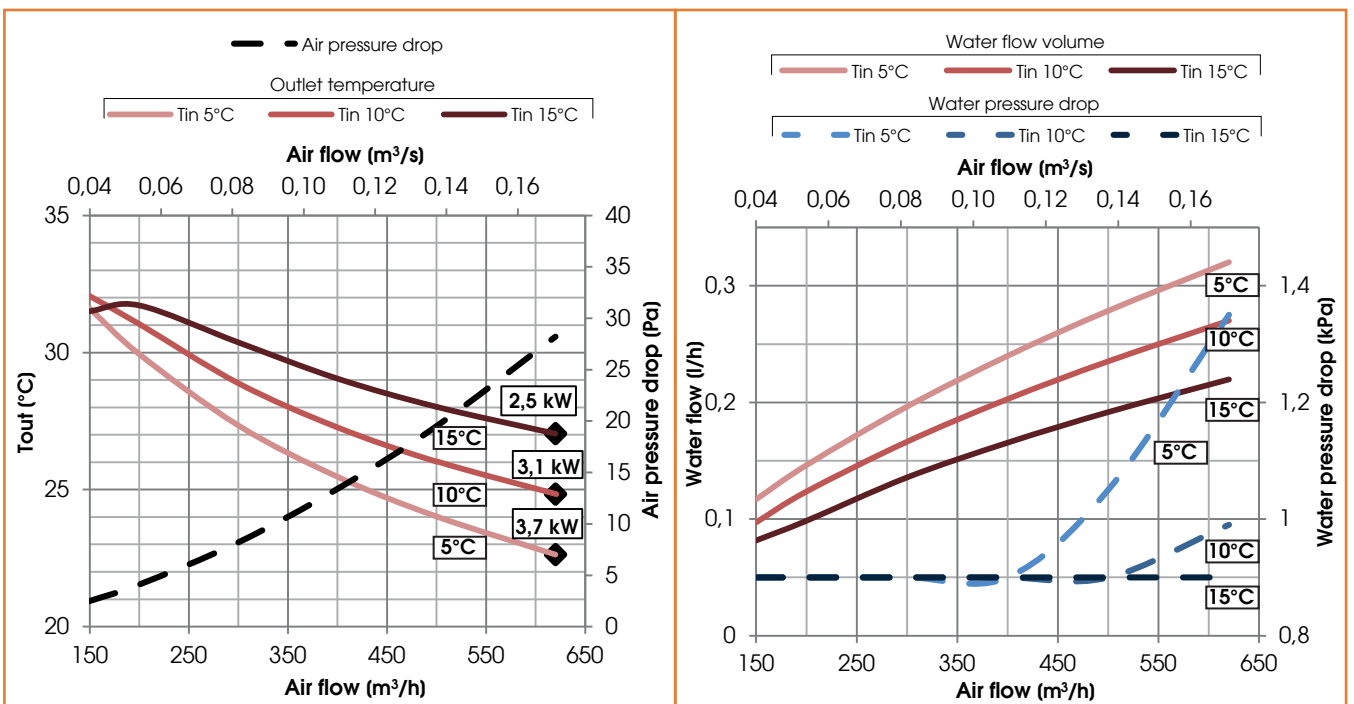



COILS CRHE-H 1100/ENT
Cooling water coil (7°C/12°C)

Ø WATER ("gas)	N. ROWS	FIN PITCH (mm)	INT.VOL. (dm³)	MATERIALS		
				TUBES	FINS	FRAME
3/4"	4	2,5	3	Cu	Al	Fe Zn

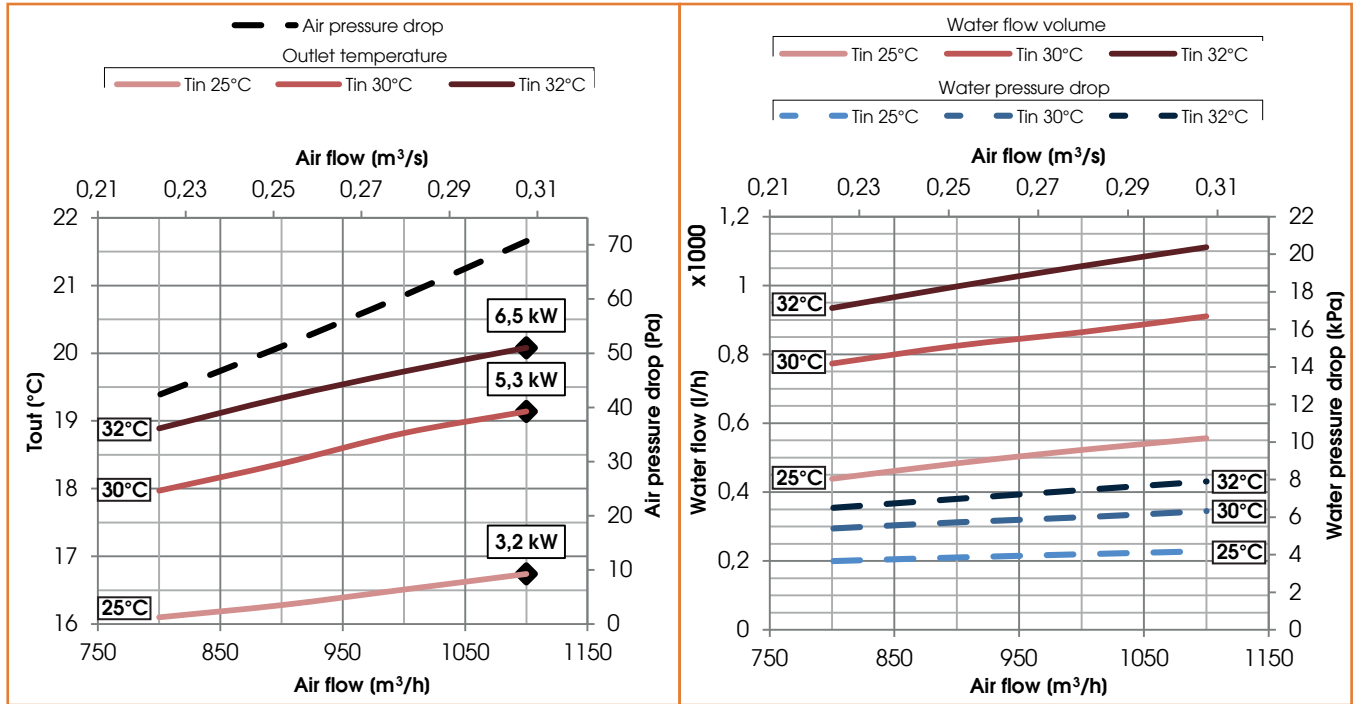

Heating water coil (45°C/35°C)

Ø WATER ("gas)	N. ROWS	FIN PITCH (mm)	INT.VOL. (dm³)	MATERIALS		
				TUBES	FINS	FRAME
3/4"	4	2,5	3	Cu	Al	Fe Zn

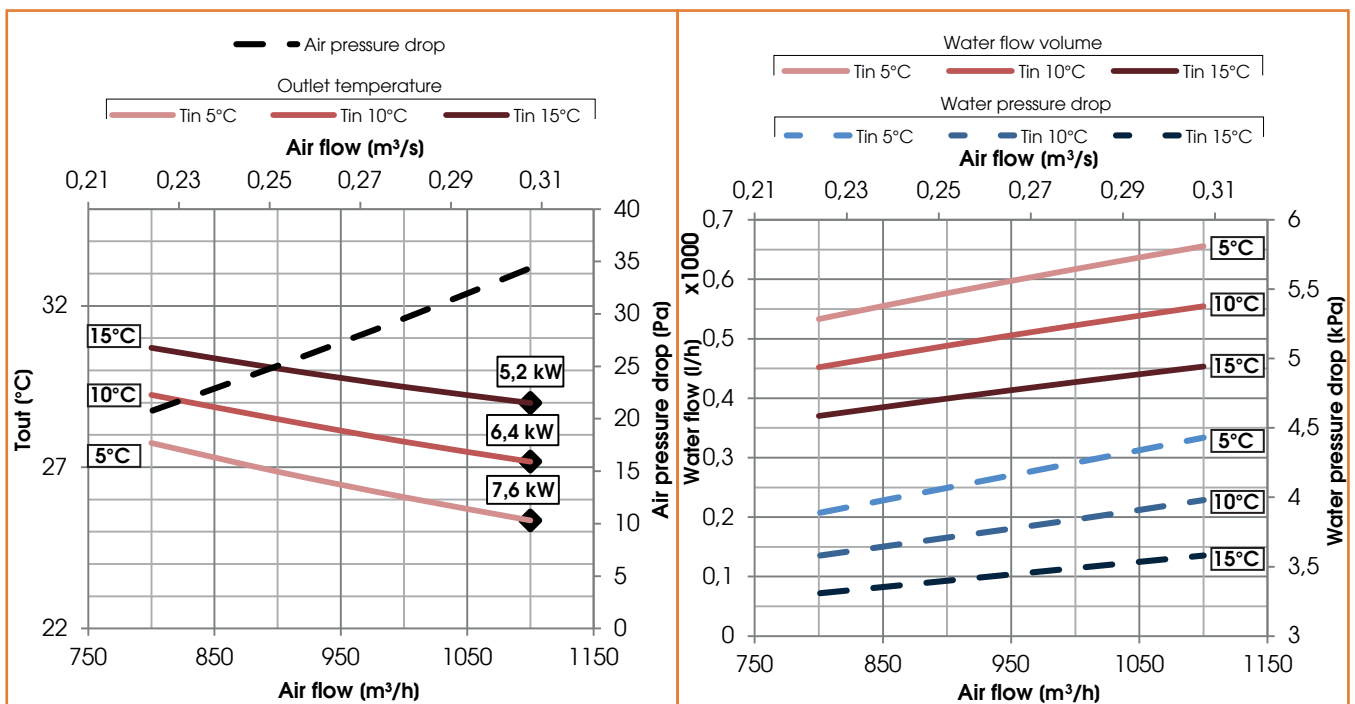



COILS CRHE-H 1600/ENT
Cooling water coil (7°C/12°C)

MATERIAL

Ø WATER ("gas)	N. ROWS	FIN PITCH (mm)	INT.VOL. (dm ³)	TUBES	FINS	FRAME
3/4"	4	2,5	5	Cu	Al	Fe Zn

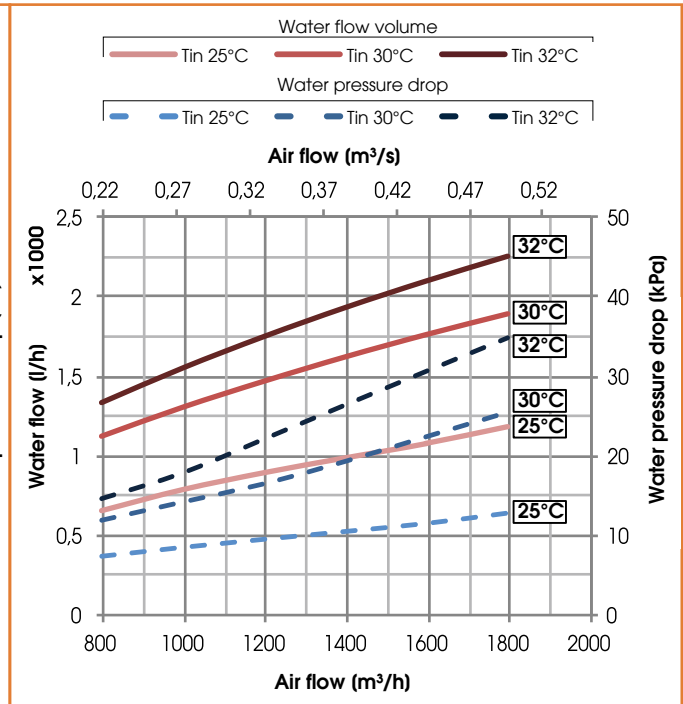
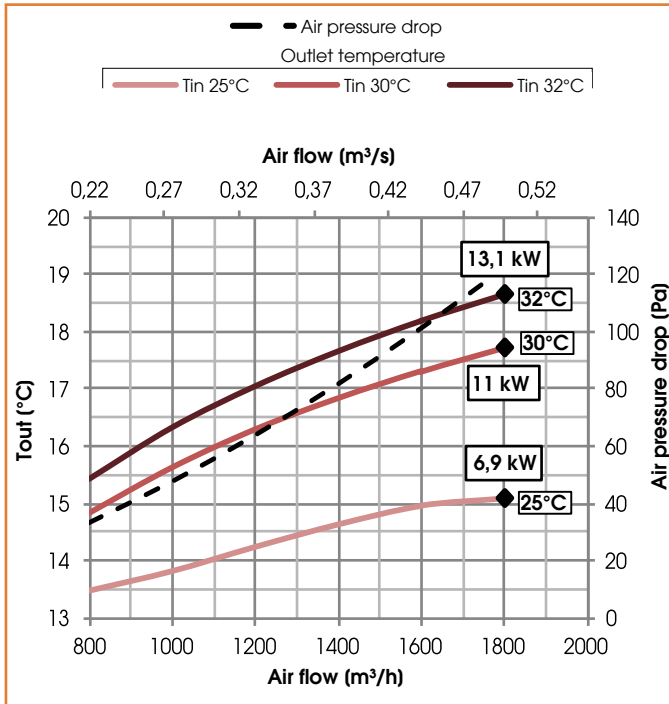

Heating water coil (45°C/35°C)

MATERIAL

Ø WATER ("gas)	N. ROWS	FIN PITCH (mm)	INT.VOL. (dm ³)	TUBES	FINS	FRAME
3/4"	4	2,5	5	Cu	Al	Fe Zn

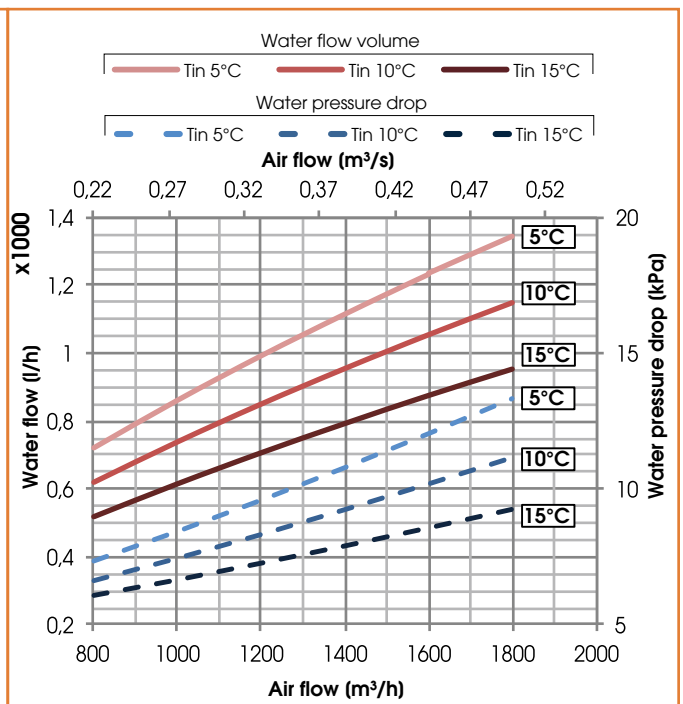
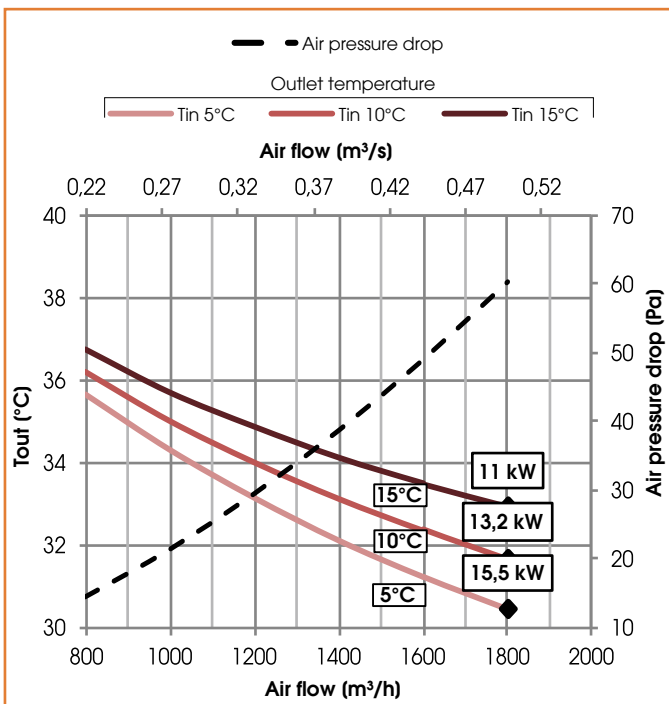



COILS CRHE-H 2300/ENT
Cooling water coil (7°C/12°C)

Ø WATER ("gas)	N. ROWS	FIN PITCH (mm)	INT.VOL. (dm³)	MATERIALS		
				TUBES	FINS	FRAME
3/4"	4	2,5	5	Cu	Al	Fe Zn

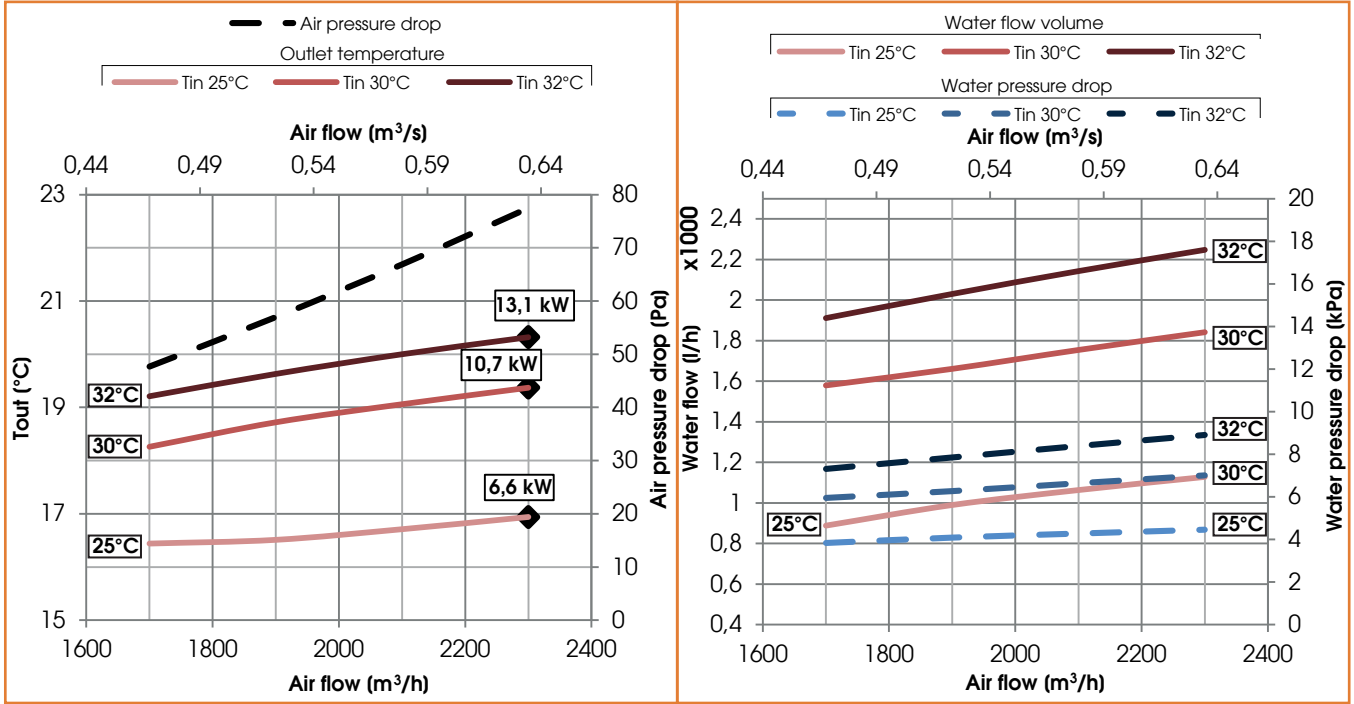

Heating water coil (45°C/35°C)

Ø WATER ("gas)	N. ROWS	FIN PITCH (mm)	INT.VOL. (dm³)	MATERIALS		
				TUBES	FINS	FRAME
3/4"	4	2,5	5	Cu	Al	Fe Zn

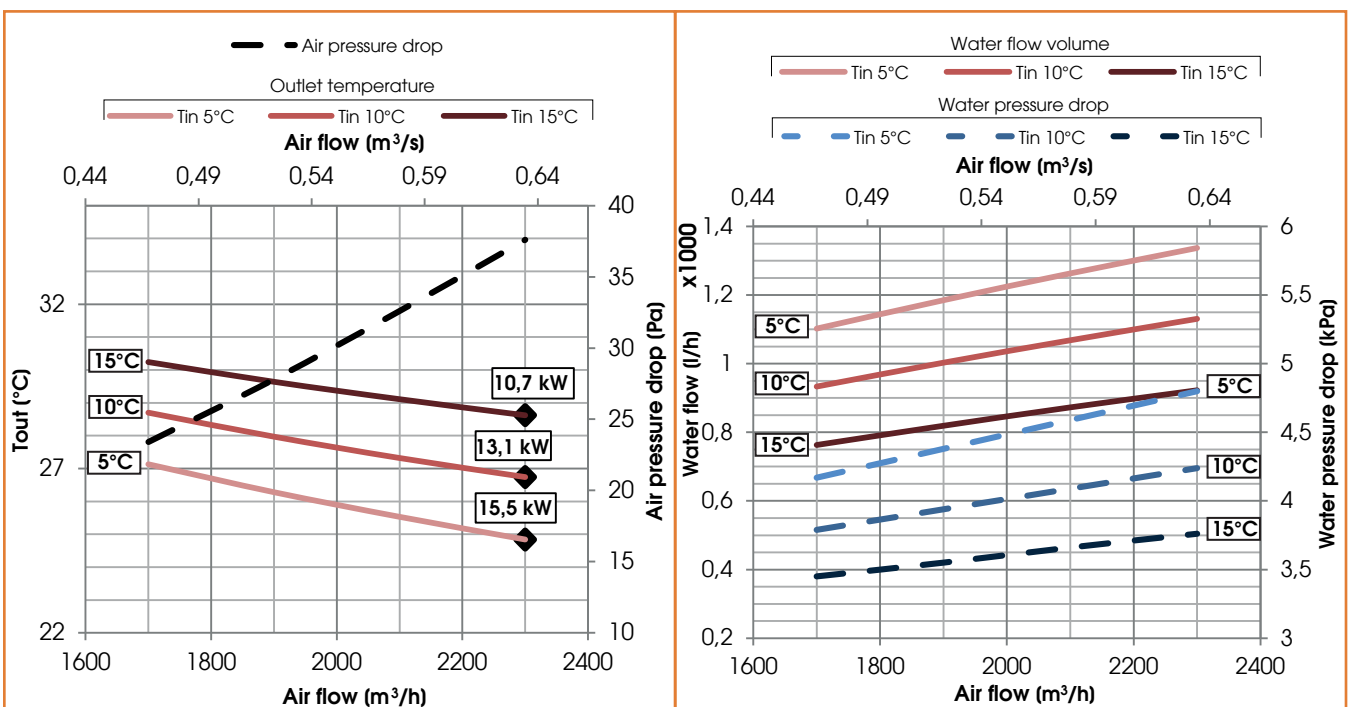



COILS CRHE-H 3400/ENT
Cooling water coil (7°C/12°C)

Ø WATER (”gas)	N. ROWS	FIN PITCH (mm)	INT.VOL. (dm ³)	MATERIALS		
				TUBES	FINS	FRAME
3/4"	2	2,5	5	Cu	Al	Fe Zn

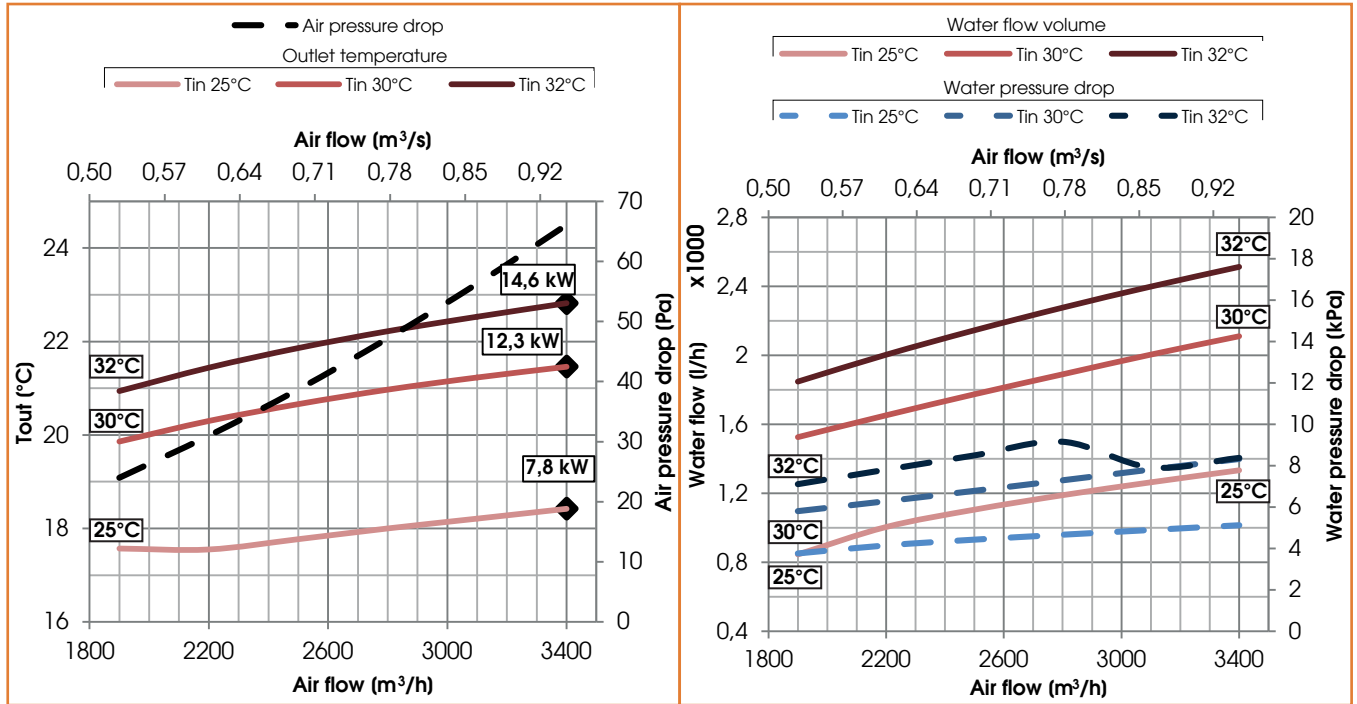

Heating water coil (45°C/35°C)

Ø WATER (”gas)	N. ROWS	FIN PITCH (mm)	INT.VOL. (dm ³)	MATERIALS		
				TUBES	FINS	FRAME
3/4"	2	2,5	5	Cu	Al	Fe Zn

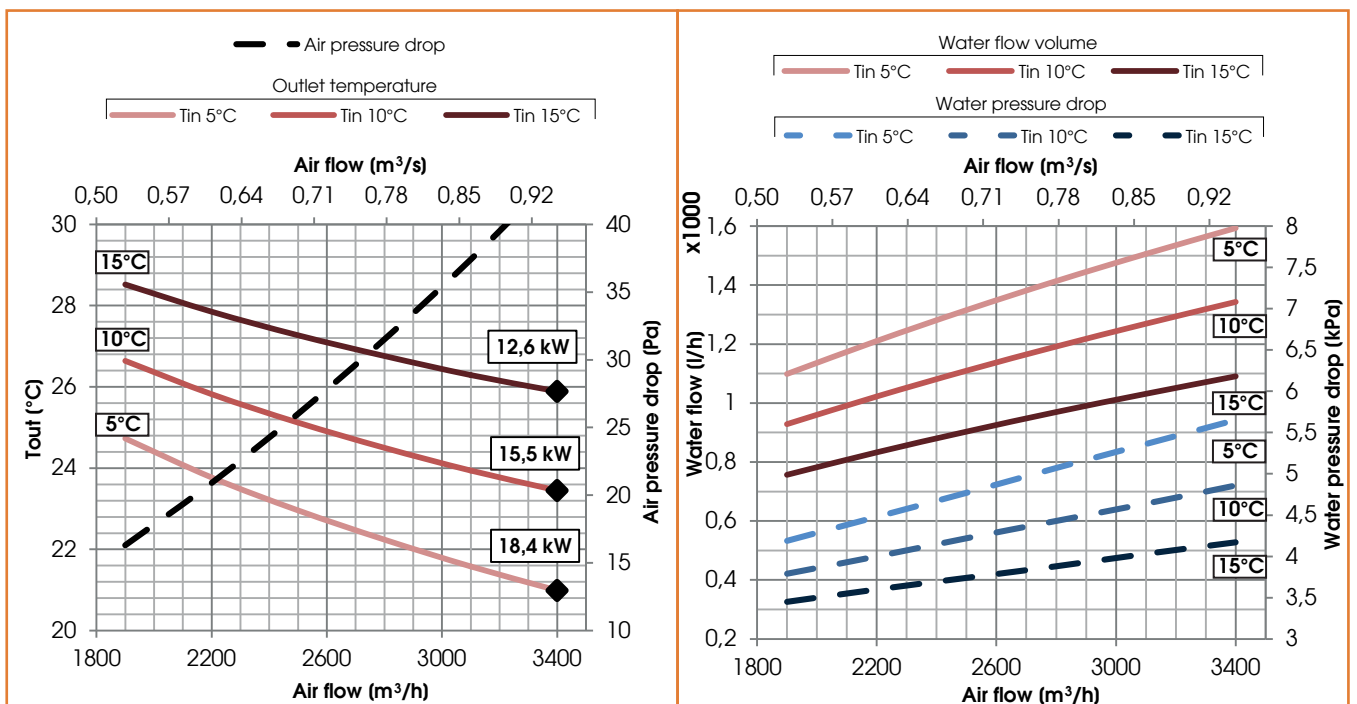



DX coil CRHE-H 700

DIRECT EXPANSION COIL (R410A) TECHNICAL DATA

Air flow (m³/h)	Tin (C°)	R.H in (%)	Power (kW)	Tout (°C)	R.H: out (%)	Air pressure drop (Pa)
500	28	80	5,5	17	100	90
Ø Connection (mm)	Fin pitch (mm)	N. Rows	Int.Vol. (dm³)	T evap (°C)	T cond (°C)	
22-12	2,5	4	1	5	50	

DX coil CRHE-H 1100/ENT

DIRECT EXPANSION COIL (R410A) TECHNICAL DATA

Air flow (m³/h)	Tin (C°)	R.H in (%)	Power (kW)	Tout (°C)	R.H: out (%)	Air pressure drop (Pa)
1100	28	68	11	15	98	73
Ø Connection (mm)	Fin pitch (mm)	N. Rows	Int.Vol. (dm³)	T evap (°C)	T cond (°C)	
28-16	2,5	4	3	5	50	

DX coil CRHE-H 1600/ENT

DIRECT EXPANSION COIL (R410A) TECHNICAL DATA

Air flow (m³/h)	Tin (C°)	R.H in (%)	Power (kW)	Tout (°C)	R.H: out (%)	Air pressure drop (Pa)
1600	28	68	13	16	100	77
Ø Connection (mm)	Fin pitch (mm)	N. Rows	Int.Vol. (dm³)	T evap (°C)	T cond (°C)	
22-16	3,0	4	3	5	50	

DX coil CRHE-H 2300/ENT

DIRECT EXPANSION COIL (R410A) TECHNICAL DATA

Air flow (m³/h)	Tin (C°)	R.H in (%)	Power (kW)	Tout (°C)	R.H: out (%)	Air pressure drop (Pa)
2300	28	68	17	18,5	92	49
Ø Connection (mm)	Fin pitch (mm)	N. Rows	Int.Vol. (dm³)	T evap (°C)	T cond (°C)	
28-22	4,0	4	5	5	50	

DX coil CRHE-H 3400/ENT

DIRECT EXPANSION COIL (R410A) TECHNICAL DATA

Air flow (m³/h)	Tin (C°)	R.H in (%)	Power (kW)	Tout (°C)	R.H: out (%)	Air pressure drop (Pa)
3400	28	68	27	16	99	96
Ø Connection (mm)	Fin pitch (mm)	N. Rows	Int.Vol. (dm³)	T evap (°C)	T cond (°C)	
35-16	3	4	6	5	50	

Electrical heater

POST ELECTRICAL HEATER TECHNICAL DATA

Unit	Power supply	Power (kW)	Current (A)	N. stages
CRHE-H 700	230V, 50Hz,1F	2	8,7	1
CRHE-H 1100/ENT	230V, 50Hz,1F	3	13,0	1
CRHE-H 1600/ENT	230V, 50Hz,1F	6	26,1	1
CRHE-H 2300/ENT	230V, 50Hz,1F	6	26,0	1
CRHE-H 3400/ENT	230V, 50Hz,1F	8	34,7	1
CRHE-H 3400/ENT	400V, 50Hz,3F	8	11,5	1

N.B. – for other batteries PRE or POST treatment see the Techno-list of ACCESSORIES

A	Manufacturer's name	UTEK srl		
B	Manufacturer's model identifier	CRHE 700EC BP EVO-PH SH	CRHE 1100EC BP EVO-PH SH	CRHE 1600EC BP EVO-PH SH
C	Declared typology	UVNR / UVB		
D	Type of drive installed	Variable speed drive	Variable speed drive	Variable speed drive
E	Type of HRS	other	other	other
F	Thermal efficiency of heat recovery (%)	80,0	84,0	81,8
G	Nominal NRVU flow rate (m³/s)	0,146	0,249	0,547
H	Effective electric power input (kW)	0,32	0,35	0,83
I	SFPint (W/(m³/s))	1080	529	752
J	Face velocity at design flow rate (m/s)	1,9	1,6	2,0
K	Nominal external pressure (Pa)	200	200	200
L	Internal pressure drop of ventilation components (Pa)	511	296	728
M	Optional: internal pressure drop of non-ventilation components	-	-	-
N	Static efficiency of fans used in accordance with Regulation (EU) No 327/2011 (%)	54,4	58,7	62,8
O	Declared maximum external leakage rate of the casing of ventilation units (%)	5,7	4,2	3,6
	Declared maximum internal leakage rate of bidirectional ventilation units or carry over (for regenerative heat exchangers only) (%)	11,2	4,4	5,4
P	Energy performance, preferably energy classification, of the filters (declared information about the calculated annual energy consumption	ePM1 70% (F7) ePM10 50% (M5)	ePM1 70% (F7) ePM10 50% (M5)	ePM1 70% (F7) ePM10 50% (M5)
Q	Position and description of visual filter warning for RVUs intended for use with filters, including text pointing out the importance of regular filter changes for performance and energy efficiency of the unit	Filter warning is signaled on the display of the control system: the flashing writing "DirtyFilters" will appear. "To preserve the energy efficiency of the NRVU, it's recommended to replace the filters when signaled." Positioned near the filters inspection.		
R	Casing sound power level (LWA) (dB)	52	60	63
S	Internet address for pre-/dis-assembly instructions	www.utek.it		

A	Manufacturer's name	UTEK srl		
B	Manufacturer's model identifier	CRHE 3400EC BP EVO-PH SH	CRHE 1100EC BP EVO-PH SH	CRHE 1600EC BP EVO-PH SH
C	Declared typology	UVNR / UVB	UVNR / UVB	UVNR / UVB
D	Type of drive installed	Variable speed drive	Variable speed drive	Variable speed drive
E	Type of HRS	other	other	other
F	Thermal efficiency of heat recovery (%)	81,7	76,5	75,3
G	Nominal NRVU flow rate (m³/s)	0,812	0,38	0,54
H	Effective electric power input (kW)	1,27	0,87	0,82
I	SFPint (W/(m³/s))	662	1118	774
J	Face velocity at design flow rate (m/s)	2,0	2,4	2,0
K	Nominal external pressure (Pa)	200	300	200
L	Internal pressure drop of ventilation components (Pa)	349	711	517
M	Optional: internal pressure drop of non-ventilation components	310	-	-
N	Static efficiency of fans used in accordance with Regulation (EU) No 327/2011 (%)	49,7	59,0	61,2
O	Declared maximum external leakage rate of the casing of ventilation units (%)	2,6	4,3	3,2
	Declared maximum internal leakage rate of bidirectional ventilation units or carry over (for regenerative heat exchangers only) (%)	3,1	4,4	4,7
P	Energy performance, preferably energy classification, of the filters (declared information about the calculated annual energy consumption)	ePM1 70% (F7) ePM10 50% (M5)	ePM1 70% (F7) ePM10 50% (M5)	ePM1 70% (F7) ePM10 50% (M5)
Q	Position and description of visual filter warning for RVUs intended for use with filters, including text pointing out the importance of regular filter changes for performance and energy efficiency of the unit	Filter warning is signaled on the display of the control system: the flashing writing "DirtyFilters" will appear. To preserve the energy efficiency of the NRVU, it's recommended to replace the filters when signaled." Positioned near the filters inspection.		
R	Casing sound power level (LWA) (dB)	69	52	67
S	Internet address for pre-/dis-assembly instructions			

A	Manufacturer's name	UTEK srl	
B	Manufacturer's model identifier	CRHE 3400EC BP EVO-PH SH -VERSIONE ENTALPICA-	
C	Declared typology	UVNR / UVB	
D	Type of drive installed	Variable speed drive	
E	Type of HRS	other	
F	Thermal efficiency of heat recovery (%)	75,6	
G	Nominal NRVU flow rate (m³/s)	0,79	
H	Effective electric power input (kW)	1,27	
I	SFPint (W/(m³/s))	766	
J	Face velocity at design flow rate (m/s)	1,9	
K	Nominal external pressure (Pa)	200	
L	Internal pressure drop of ventilation components (Pa)	433	
M	Optional: internal pressure drop of non-ventilation components		
N	Static efficiency of fans used in accordance with Regulation (EU) No 327/2011 (%)	52,5	
	Declared maximum external leakage rate of the casing of ventilation units (%)	2,7	
O	Declared maximum internal leakage rate of bidirectional ventilation units or carry over (for regenerative heat exchangers only) (%)	3,2	
P	Energy performance, preferably energy classification, of the filters (declared information about the calculated annual energy consumption	ePM1 70%(F7) ePM10 50%(M5)	
Q	Position and description of visual filter warning for RVUs intended for use with filters, including text pointing out the importance of regular filter changes for performance and energy efficiency of the unit	Filter warning is signaled on the display of the control system; the flashing writing "DirtyFilters" will appear. "To preserve the energy efficiency of the NRVU, it's recommended to replace the filters when signaled." Positioned near the filters inspection.	
R	Casing sound power level (LWA) (dB)	69	
S	Internet address for pre-/dis-assembly instructions		

CLA & UTEK reserves the right to at any time the necessary changes to improve products without prior notice .

Dear Customer

Thanks for your attention to the product UTEK , designed and manufactured to ensure the real values to the User : Quality, Safety and Savings on working.



Made in Italy

**AZIENDA CON SISTEMA
DI GESTIONE QUALITÀ
CERTIFICATO DA DNV GL**
ISO 9001

**AZIENDA CON
SISTEMA DI GESTIONE
AMBIENTALE CERTIFICATO
DA DNV**
ISO 14001



the Dealer

CRHE-H_2018_3_EN



VENTILATION UNIT WITH HEAT RECOVERY FOR COMMERCIAL AND INDUSTRIAL BUILDINGS

Ventas A/S - Gefionsvej 13 - 3400 Hillerød - ventas@ventas.dk - www.ventas.dk