

# HMF/ HMFx F400

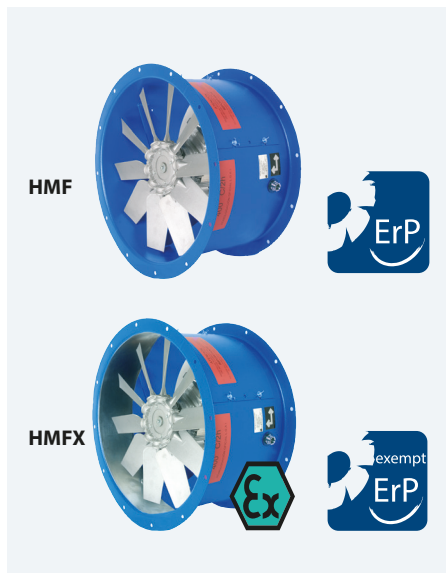

## MANUFACTURING FEATURES

- Long cased axial fan with reinforced body.
- Modular motor-impeller assembly.
- Impeller in aluminum injection with reinforced body. Protected against corrosion by powder coating of polyester resin.
- Housing with motor access door.

### HMF F400

- Standard asynchronous squirrel-cage motor with IP-55 protection and Class H insulation certified 400°C/2h. Manufactured with standard voltages 230/400V 50Hz in three phase motors up to 3kW and 400/690V 50Hz for higher powers. IE3 efficiency motor from 0,75kW up to 45kW in single speed.

### HMFx F400

- Protection ring made of aluminium.
- ATEX II3G.
- Standard asynchronous squirrel-cage motor with IP-55 protection and Class H insulation certified 400°C/2h. Manufactured with standard voltages 230/400V 50Hz in three phase motors up to 3kW and 400/690V 50Hz for higher powers. IE3 efficiency motor from 0,75kW up to 45kW in single speed.

## APPLICATIONS

- Designed for inline installation, they are suitable for:
- Smoke emergency exhaust with motor inside the hazardous area.
  - Maximum working temperature: 60°C.

## UNDER REQUEST

- B form impeller (air flow from impeller to motor). 5% additional cost.
- 100% reversible impeller. 5% additional cost.
- Different polarities.

## CARACTERÍSTICAS CONSTRUCTIVAS

- Ventilador tubular de estructura reforzada.
- Montaje modular del conjunto motor hélice.
- Hélice en inyección de aluminio. Protegidos contra la corrosión mediante recubrimiento en polvo de resina de poliéster.
- Trampilla de acceso al motor para facilitar las conexiones.

### HMF F400

- Motor asíncrono normalizado de jaula de ardilla con protección IP-55 y aislamiento clase H certificado 400°C/2h. Voltajes estándar 230/400V 50Hz para motores trifásicos hasta 3kW y 400/690V 50Hz para potencias superiores. Motor de eficiencia IE3 desde 0,75kW hasta 45kW de una velocidad.

### HMFx F400

- Anillo de protección en aluminio.
- ATEX II3G.
- Motor asíncrono normalizado de jaula de ardilla con protección IP-55 y aislamiento clase H certificado 400°C/2h. Voltajes estándar 230/400V 50Hz para motores trifásicos hasta 3kW y 400/690V 50Hz para potencias superiores. Motor de eficiencia IE3 desde 0,75kW hasta 45kW de una velocidad.

## APLICACIONES

- Diseñados para instalación en conducto, son indicados para:
- Extracción de humo en caso de incendio estando el motor dentro de la zona de riesgo.
  - Temperatura máxima de trabajo en continuo: 60°C.

## BAJO DEMANDA

- Hélice impelente (sentido de aire hélice-motor). Incremento 5% sobre PVP.
- Hélice reversible 100%. Incremento 5% sobre PVP.
- Distintas polaridades.

## ACCESSORIES / accesorios



### INT

Interruptor de corte  
Safety switch



### BA-400

Brida antivibratoria 400°C/2h  
Flexible flange 400°C/2H



### INT 400

Interruptor selector de velocidad  
Speed selector switch



### SFC

Variador de velocidad frecuencial  
Frequency speed controller



### RPO

Rejilla de protección  
Outlet protection guard



### JE 45

Junta elástica  
Flexible joint



### AC

Brida conexión  
Connection flange



### BAD

Brida antivibratoria circular-circular  
Coupling flange



### RP1

Rejilla de protección  
Inlet protection guard



### PC2

Rejilla de sobrepresión antirretorno  
Overpressure damper for facade

**THREE PHASE RANGE / serie trifásica**
**2 POLE/ 2 polos**

Model	Angle	Min. Rat. power kW	Max. Rat. power kW	Air flow m <sup>3</sup> /h	Sound dB (A) **	Weight kg *	Connection diagram
HMF 45 T2 (A8:6) F400	20° - 45°	1,1	2,2	12.400	64	19,1	1
HMF 45 T2 (A8:9) F400	20° - 45°	1,5	2,2	11.700	65	19,7	1
HMF 45 T2 (A8:12) F400	20° - 45°	1,5	3	11.800	64	20,2	1
HMF 50 T2 (A8:6) F400	20° - 45°	1,5	4	16.200	67	24,8	1
HMF 50 T2 (A8:9) F400	20° - 45°	2,2	4	14.400	68	25,4	1
HMF 50 T2 (A8:12) F400	20° - 45°	2,2	4	14.400	66	26	1
HMF 56 T2 (A8:6) F400	20° - 45°	2,2	7,5	23.700	70	29,8	1
HMF 56 T2 (A8:9) F400	20° - 45°	2,2	7,5	24.800	70	30,5	1
HMF 56 T2 (A8:12) F400	20° - 45°	3	7,5	22.300	70	31,2	1

**4 POLE/ 4 polos**

Model	Angle	Min. Rat. power kW	Max. Rat. power kW	Air flow m <sup>3</sup> /h	Sound dB (A) **	Weight kg *	Connection diagram
HMF 45 T4 (A5:6) F400	20° - 42,5°	0,75	0,75	6.150	51	18,4	1
HMF 50 T4 (A5:6) F400	25° - 45°	0,75	0,75	9.200	55	24,2	1
HMF 56 T4 (A5:6) F400	20° - 45°	0,75	1,5	14.630	70	29,4	1
HMF 63 T4 (A5:6) F400	20° - 45°	0,75	2,2	20.340	74	34	1
HMF 71 T4 (A5:6) F400	20° - 45°	0,75	3	27.510	79	40,1	1
HMF 80 T4 (A5:6) F400	20° - 45°	2,2	4	34.460	76	46,1	1
HMF 90 T4 (A3:4) F400	20° - 42°	3	15	48.110	73	75,4	1
HMF 90 T4 (A3:8) F400	20° - 42°	3	15	54.810	78	80,5	1
HMF 100 T4 (A3:4) F400	20° - 42°	5,5	22	67.210	72	93,8	1
HMF 100 T4 (A3:8) F400	20° - 42°	5,5	22	77.810	81	99,4	1
HMF 112 T4 (A3:4) F400	20° - 42°	7,5	37	92.110	76	115,1	1
HMF 112 T4 (A3:8) F400	20° - 42°	7,5	37	104.010	83	121,2	1
HMF 125 T4 (A3:4) F400	20° - 42°	11	45	124.010	83	128,9	1
HMF 125 T4 (A3:8) F400	20° - 42°	11	45	141.010	89	135,5	1

**6 POLE/ 6 polos**

Model	Angle	Min. Rat. power kW	Max. Rat. power kW	Air flow m <sup>3</sup> /h	Sound dB (A) **	Weight kg *	Connection diagram
HMF 45 T6 (A5:6) F400	25° - 45°	0,75	0,75	4.060	42	18,4	1
HMF 50 T6 (A5:6) F400	25° - 45°	0,75	0,75	5.950	46	24,2	1
HMF 56 T6 (A5:6) F400	20° - 45°	0,75	0,75	9.760	67	29,4	1
HMF 63 T6 (A5:6) F400	20° - 45°	0,75	0,75	13.560	71	34	1
HMF 71 T6 (A5:6) F400	20° - 45°	0,75	0,75	18.340	76	40,1	1
HMF 80 T6 (A5:6) F400	20° - 45°	0,75	2,2	25.190	72	46,1	1
HMF 90 T6 (A3:4) F400	20° - 42°	1,5	5,5	31.210	63	75,4	1
HMF 90 T6 (A3:8) F400	20° - 42°	1,5	5,5	35.510	68	80,5	1
HMF 100 T6 (A3:4) F400	20° - 42°	1,5	7,5	43.610	63	93,8	1
HMF 100 T6 (A3:8) F400	20° - 42°	1,5	7,5	50.410	71	99,4	1
HMF 112 T6 (A3:4) F400	20° - 42°	2,2	11	59.710	66	115,1	1
HMF 112 T6 (A3:8) F400	20° - 42°	2,2	11	67.610	73	121,2	1
HMF 125 T6 (A3:4) F400	20° - 42°	3	15	80.610	73	128,9	1
HMF 125 T6 (A3:8) F400	20° - 42°	3	15	91.410	80	135,5	1

**THREE PHASE RANGE 2 SPEEDS / serie trifásica 2 velocidades**
**2/4 POLE / 2/4 polos**

Model	Angle	Min. Rat. power kW	Max. Rat. power kW	Air flow m <sup>3</sup> /h	Sound dB (A) **	Weight kg *	Connection diagram
HMF 45 T2/T4 (A8:6) F400	20° - 45°	1,1	3,1	12.400	64	19,1	1
HMF 45 T2/T4 (A8:9) F400	20° - 45°	1,5	3,1	11.700	65	19,7	1
HMF 45 T2/T4 (A8:12) F400	20° - 45°	1,5	4,4	11.800	64	20,2	1
HMF 50 T2/T4 (A8:6) F400	20° - 45°	1,5	4,4	16.200	67	24,8	1
HMF 50 T2/T4 (A8:9) F400	20° - 45°	2,2	4,4	14.400	68	25,4	1
HMF 50 T2/T4 (A8:12) F400	20° - 45°	2,2	4,4	14.400	66	26	1
HMF 56 T2/T4 (A8:6) F400	20° - 45°	2,2	8	23.700	70	29,8	1
HMF 56 T2/T4 (A8:9) F400	20° - 45°	2,2	8	24.800	70	30,5	1
HMF 56 T2/T4 (A8:12) F400	20° - 45°	2,2	8	22.300	70	31,2	1

**4/6 POLE / 4/6 polos**

Model	Angle	Min. Rat. power kW	Max. Rat. power kW	Air flow m <sup>3</sup> /h	Sound dB (A) **	Weight kg *	Connection diagram
HMF 56 T4/T6 (A5:6) F400	20° - 45°	0,55	2,2	14.630	70	29,4	2
HMF 63 T4/T6 (A5:6) F400	20° - 45°	0,55	2,2	20.340	74	34	2
HMF 71 T4/T6 (A5:6) F400	20° - 45°	0,55	3	27.510	79	40,1	2
HMF 80 T4/T6 (A5:6) F400	20° - 45°	1,1	4,5	34.460	76	46,1	2
HMF 90 T4/T6 (A3:4) F400	20° - 42°	2,2	14	48.110	73	75,4	2
HMF 90 T4/T6 (A3:8) F400	20° - 42°	2,2	14	54.810	78	80,5	2
HMF 100 T4/T6 (A3:4) F400	20° - 42°	4,5	20	67.210	72	93,8	2
HMF 112 T4/T6 (A3:4) F400	20° - 42°	4,5	26	92.110	76	115,1	2

**4/8 POLE / 4/8 polos**

Model	Angle	Min. Rat. power kW	Max. Rat. power kW	Air flow m <sup>3</sup> /h	Sound dB (A) **	Weight kg *	Connection diagram
HMF 45 T4/T8 (A5:6) F400	20° - 45°	0,6	1,6	7.300	51	18,4	1
HMF 50 T4/T8 (A5:6) F400	20° - 45°	0,6	1,6	9.500	55	24,2	1
HMF 56 T4/T8 (A5:6) F400	20° - 45°	0,6	2,8	14.630	70	29,4	3
HMF 63 T4/T8 (A5:6) F400	20° - 45°	0,6	2,8	20.340	74	34	3
HMF 71 T4/T8 (A5:6) F400	20° - 45°	0,6	4	27.510	79	40,1	3
HMF 80 T4/T8 (A5:6) F400	20° - 45°	1,2	7,5	34.460	76	46,1	3
HMF 90 T4/T8 (A3:4) F400	20° - 42°	2,2	17	48.110	73	75,4	3
HMF 90 T4/T8 (A3:8) F400	20° - 42°	2,2	17	54.810	78	80,5	3
HMF 100 T4/T8 (A3:4) F400	20° - 42°	4	20	67.210	72	93,8	3
HMF 100 T4/T8 (A3:8) F400	20° - 42°	4	20	77.810	81	99,4	3
HMF 112 T4/T8 (A3:4) F400	20° - 42°	5,5	37	92.110	76	115,1	3
HMF 112 T4/T8 (A3:8) F400	20° - 42°	5,5	37	104.010	83	121,2	3
HMF 125 T4/T8 (A3:4) F400	20° - 42°	7,5	44	124.010	83	128,9	3
HMF 125 T4/T8 (A3:8) F400	20° - 42°	7,5	44	141.010	89	135,5	3

\*\* Total sound pressure level at the point of maximum flow measured in dB(A) in the suction measured in free field at a distance of 6m from the source.

\*\* Nivel de presión sonora total en el punto de caudal máximo medido en dB(A) en la aspiración, medido en campo libre a una distancia de 6m de la fuente.

**DIMENSIONS / dimensiones**

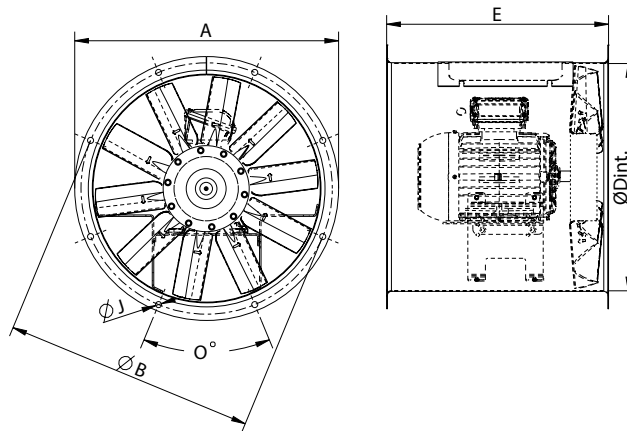

model	ØA	ØB	ØD	E	ØI	O
HMF 30M2-T2	374	355	305	350	10	8x45°
HMF 35	434	395	365	350	10	8x45°
HMF 35M2-T2	434	395	365	395	10	8x45°
HMF 40	472	450	403	440	10	8x45°
HMF 45	525	500	452	455	12	8x45°
HMF 50	600	560	504	440	12	12x30°
HMF 50M2-T2	600	560	504	540	12	12x30°
HMF 56	646	620	559	560	12	12x30°
HMF 63	725	690	633	550	12	12x30°
HMF 63M2-T2	725	690	633	770	12	12x30°
HMF 71	802	770	715	600	12	16x22,5°
HMF 71M2-T2	802	770	715	770	12	16x22,5°
HMF 80	892	860	801	600	12	16x22,5°
HMF 90	1000	970	903,5	820	12	16x22,5°
HMF 100	1115	1070	1013	820	12	16x22,5°
HMF 112	1234	1190	1132	1000	12	16x22,5°
HMF 125	1365	1320	1263	1000	15	20x18°

**CONNECTION DIAGRAMS / esquema de conexiones**

**1 THREE PHASE MOTORS 1 SPEED / motores trifásicos 1 velocidad**

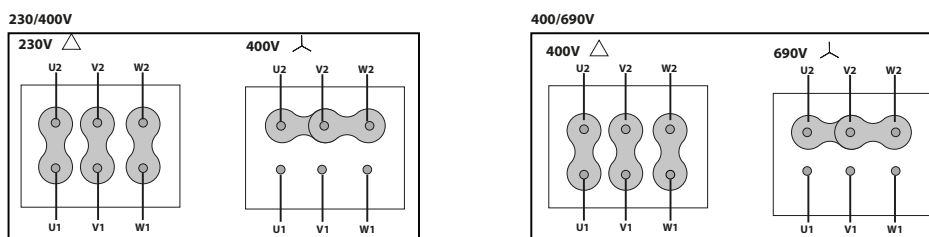

**2 400V DAHLANDER**

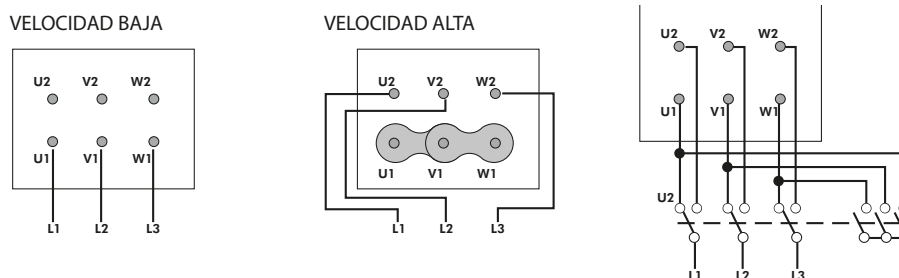

**CONSULT / consultar - HBF / HBFX F400**

**CHARACTERISTIC CURVES / curvas características**

pg.497



**HMF 45 T2 (A8:6) F400**

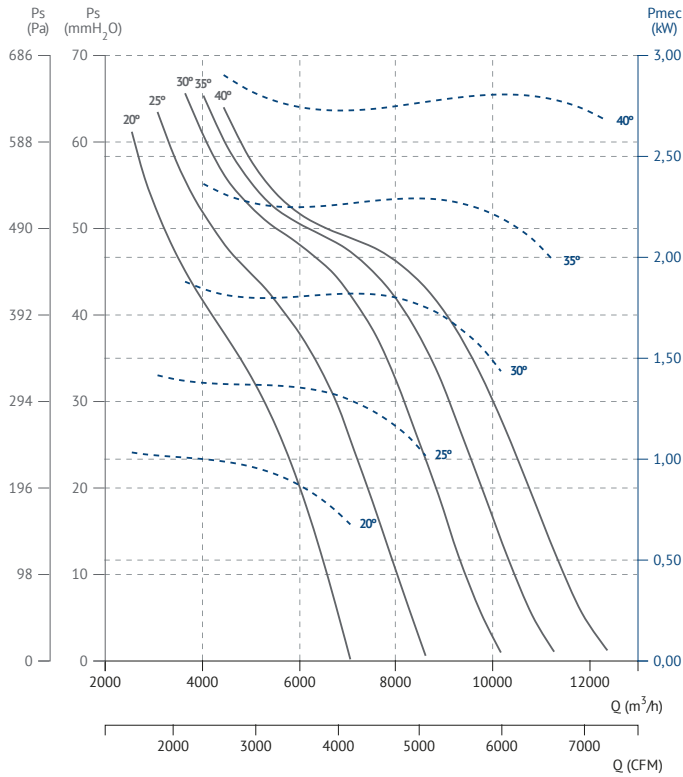

**HMF 45 T2 (A8:9) F400**

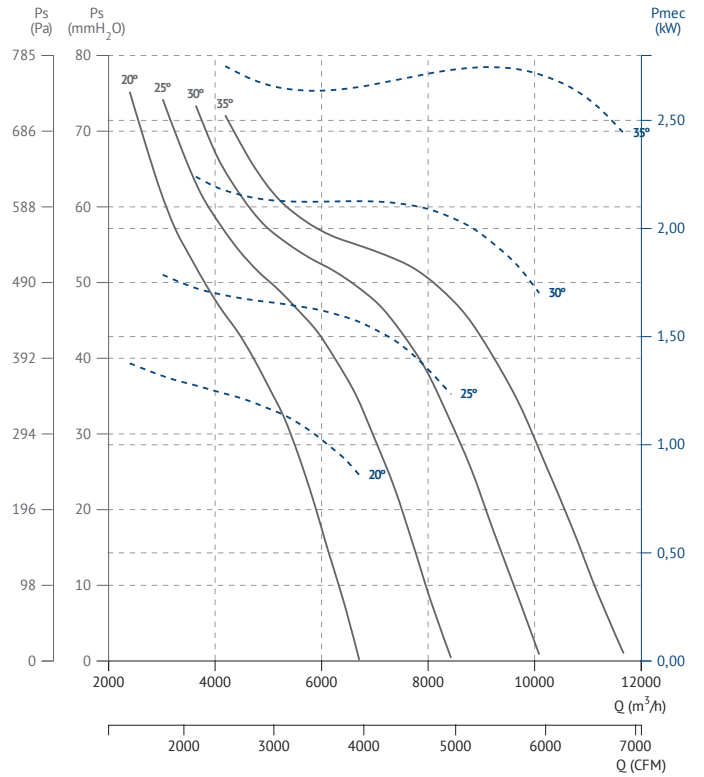

**HMF 45 T2 (A8:12) F400**

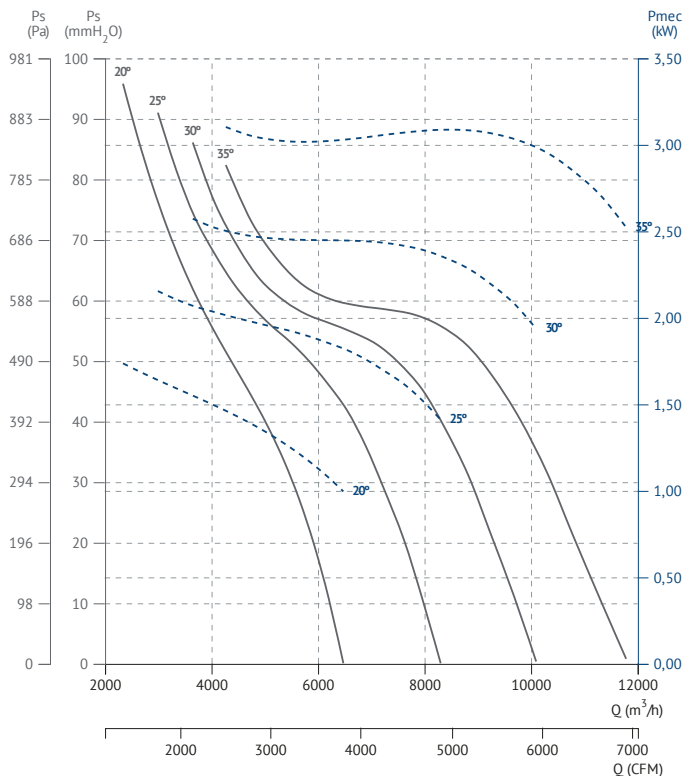

**HMF 50 T2 (A8:6) F400**

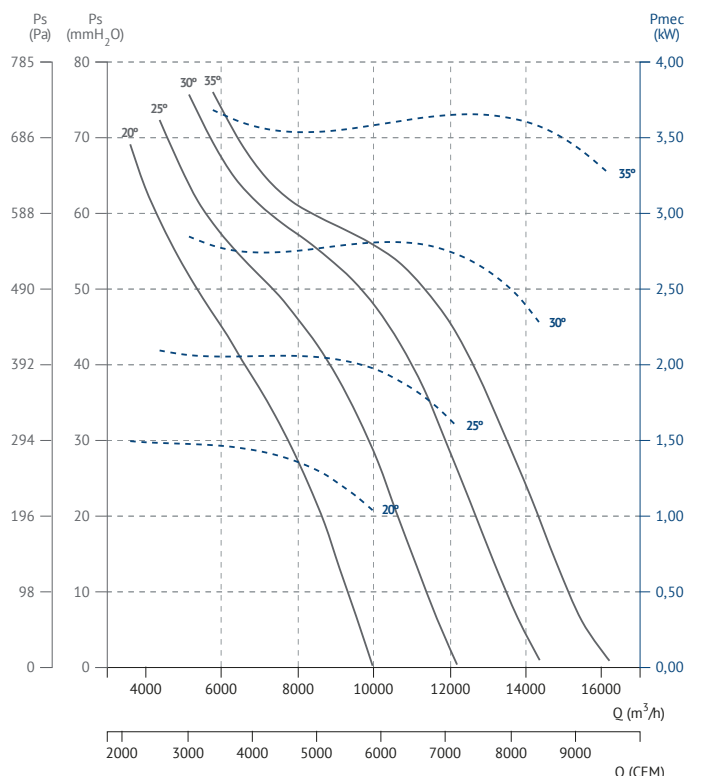



**HMF 50 T2 (A8:9) F400**

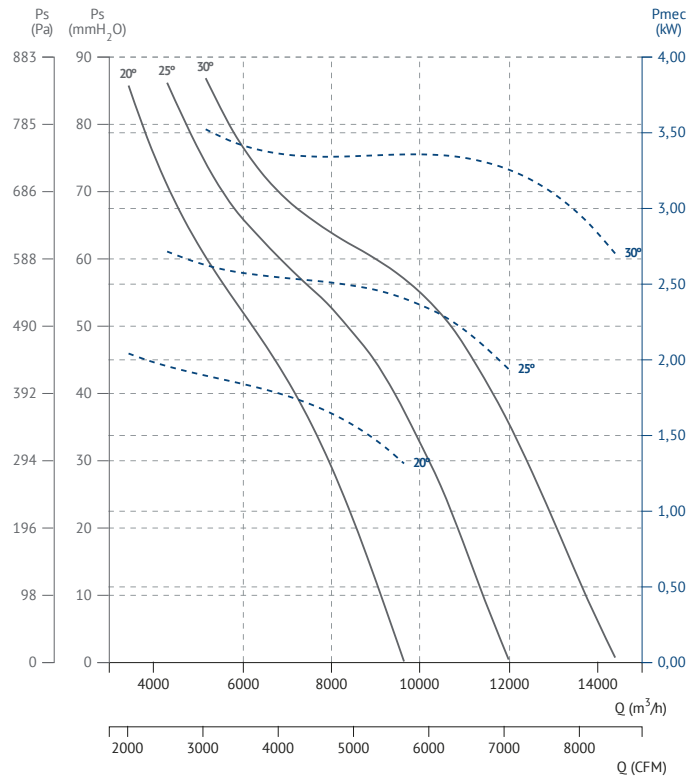

**HMF 50 T2 (A8:12) F400**

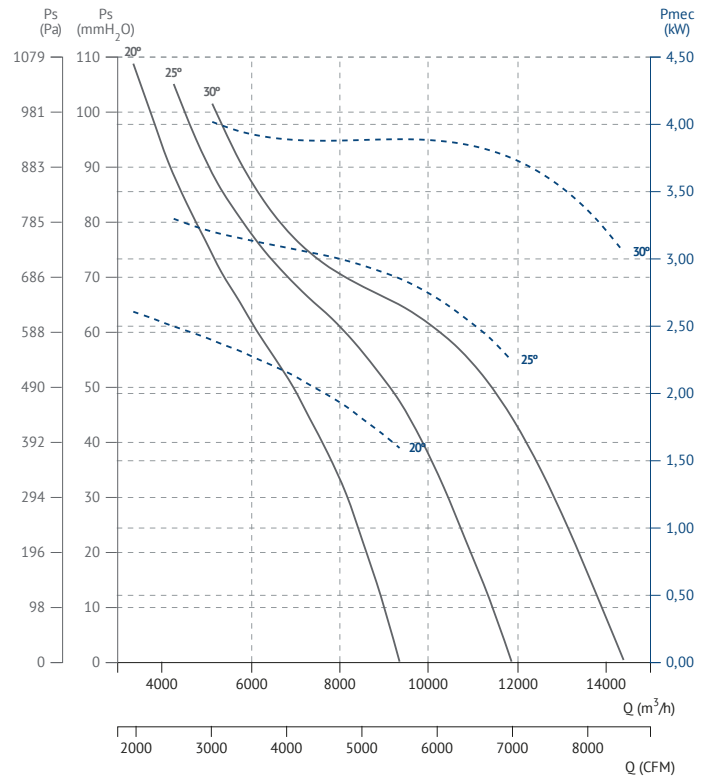

**HMF 56 T2 (A8:6) F400**

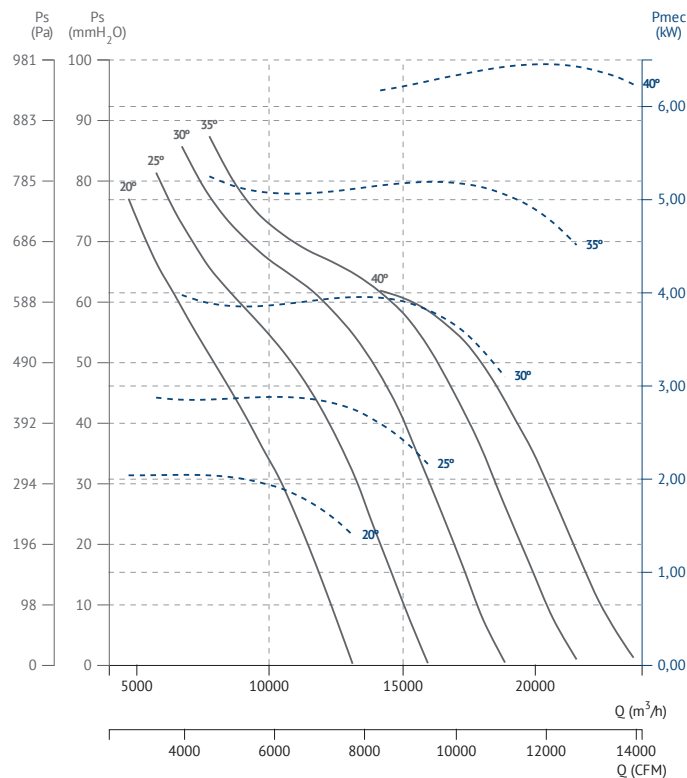

**HMF 56 T2 (A8:9) F400**

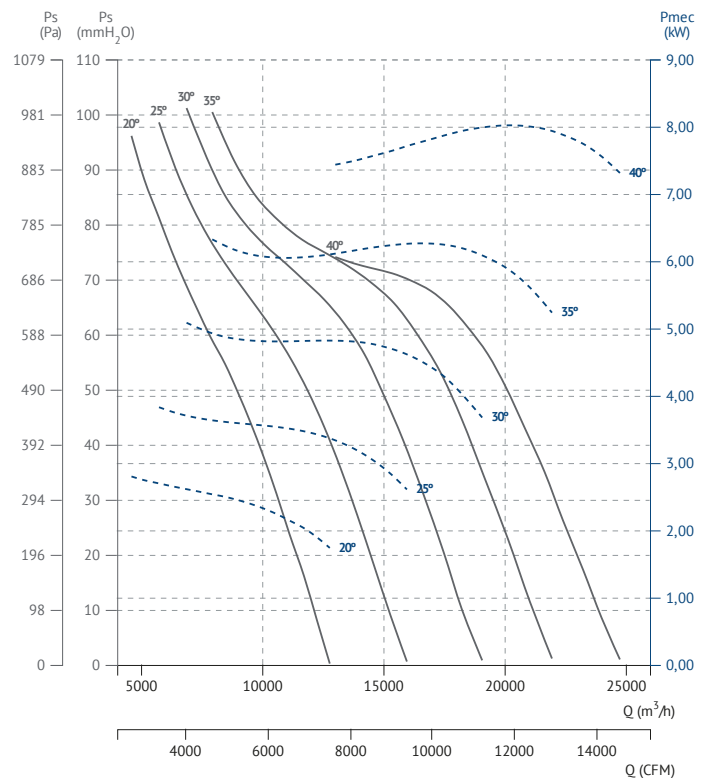

# HMF/ HMFx F300

Cased axial fan F300

Helicoidal tubular F300

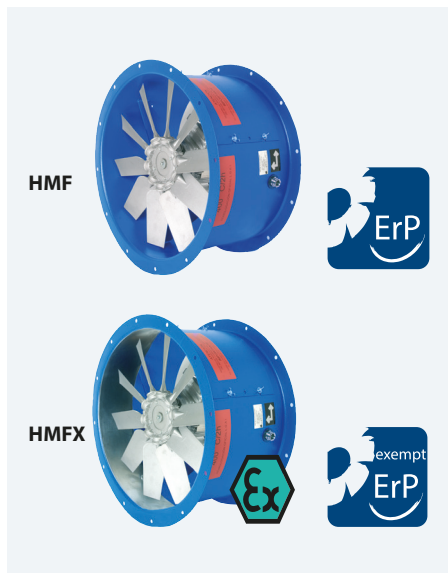

## MANUFACTURING FEATURES

- Long cased axial fan with reinforced body.
- Modular motor-impeller assembly.
- Impeller in aluminum injection with reinforced body. Protected against corrosion by powder coating of polyester resin.
- Housing with motor access door.

### HMF F300

- Standard asynchronous squirrel-cage motor with IP-55 protection and Class H insulation certified 300°C/2h. Manufactured with standard voltages: 230/400V 50Hz in three phase motors up to 3kW, and 400/690V 50Hz for higher powers. IE3 efficiency motor from 0,75kW up to 45kW in single speed.

### HMFx

- Protection ring made of aluminium.
- ATEX II3G.
- Standard asynchronous squirrel-cage motor with IP-55 protection and Class H insulation certified 400°C/2h. Manufactured with standard voltages 230/400V 50Hz in three phase motors up to 3kW and 400/690V 50Hz for higher powers. IE3 efficiency motor from 0,75kW up to 45kW in single speed.

## APPLICATIONS

- Designed for inline installation, they are suitable for:
- Smoke emergency exhaust with motor inside the hazardous area.
  - Maximum working temperature: 60°C.

## UNDER REQUEST

- B form impeller (air flow from impeller to motor). 5% additional cost.
- 100% reversible impeller. 5% additional cost.
- Different polarities.

## CARACTERÍSTICAS CONSTRUCTIVAS

- Ventilador tubular de estructura reforzada.
- Montaje modular del conjunto motor hélice.
- Hélice en inyección de aluminio. Protegidos contra la corrosión mediante recubrimiento en polvo de resina de poliéster.
- Trampilla de acceso al motor para facilitar las conexiones.

### HMF F300

- Motor asíncrono normalizado de jaula de ardilla con protección IP-55 y aislamiento clase H certificado 300°C/2h. Voltajes estándar 230/400V 50Hz para motores trifásicos hasta 3kW y 400/690V 50Hz para potencias superiores. Motor de eficiencia IE3 desde 0,75kW hasta 45kW de una velocidad.

### HMFx F300

- Anillo de protección en aluminio.
- ATEX II3G.
- Motor asíncrono normalizado de jaula de ardilla con protección IP-55 y aislamiento clase H certificado 300°C/2h. Voltajes estándar 230/400V 50Hz para motores trifásicos hasta 3kW y 400/690V 50Hz para potencias superiores. Motor de eficiencia IE3 desde 0,75kW hasta 45kW de una velocidad.

## APLICACIONES

- Diseñados para instalación en conducto, son indicados para:
- Extracción de humo en caso de incendio estando el motor dentro de la zona de riesgo.
  - Temperatura máxima de trabajo en continuo: 60°C.

## BAJO DEMANDA

- Hélice impelente (sentido de aire hélice-motor). Incremento 5% sobre PVP.
- Hélice reversible 100%. Incremento 5% sobre PVP.
- Distintas polaridades.



## ACCESSORIES / accesorios



### INT

Interruptor de corte  
Safety switch



### BA-400

Brida antivibratoria 400°C/2h  
Flexible flange 400°C/2H



### INT 400

Interruptor selector de velocidad  
Speed selector switch



### SFC

Variador de velocidad frecuencial  
Frequency speed controller



### RPO

Rejilla de protección  
Outlet protection guard



### JE 45

Junta elástica  
Flexible joint



### AC

Brida conexión  
Connection flange



### BAD

Brida antivibratoria circular-circular  
Coupling flange



### RP1

Rejilla de protección  
Inlet protection guard



### PC2

Rejilla de sobrepresión antirretorno  
Overpressure damper for facade

**THREE PHASE RANGE / serie trifásica**
**4 POLE/ 4 polos**

Model	Angle	Min. Rat. power kW	Max. Rat. power kW	Air flow m <sup>3</sup> /h	Sound dB (A) **	Weight kg *	Connection diagram
HMF 45 T4 (A2:6) F300	20° - 45°	0,55	0,75	6.640	55	17	1
HMF 45 T4 (A2:9) F300	20° - 45°	0,55	0,75	7.000	55	17,5	1
HMF 50 T4 (A2:6) F300	20° - 45°	0,55	1,1	9.460	59	22,7	1
HMF 50 T4 (A2:9) F300	20° - 45°	0,55	1,1	10.110	59	23,2	1
HMF 56 T4 (A2:6) F300	20° - 45°	0,55	2,2	13.100	61	27,7	1
HMF 56 T4 (A2:9) F300	20° - 45°	0,55	2,2	13.810	61	28,2	1
HMF 63 T4 (A2:6) F300	20° - 45°	0,55	3	19.010	63	32,1	1
HMF 63 T4 (A2:9) F300	20° - 45°	0,55	3	20.610	63	32,6	1
HMF 71 T4 (A2:6) F300	20° - 45°	0,75	4	26.410	66	38	1
HMF 71 T4 (A2:9) F300	20° - 45°	0,75	4	28.710	68	38,6	1
HMF 80 T4 (A2:6) F300	20° - 45°	1,1	7,5	37.010	68	43,7	1
HMF 80 T4 (A2:9) F300	20° - 45°	1,1	7,5	39.610	73	44,4	1
HMF 90 T4 (A6:3) F300	20° - 42°	3	15	48.350	76	72,7	1
HMF 90 T4 (A6:6) F300	20° - 42°	3	15	55.210	77	78,1	1
HMF 100 T4 (A6:3) F30	20° - 42°	5,5	22	65.950	77	91,1	1
HMF 100 T4 (A6:6) F30	20° - 42°	5,5	22	77.010	81	97,2	1
HMF 112 T4 (A6:3) F30	20° - 42°	5,5	37	86.990	79	112,6	1
HMF 112 T4 (A6:6) F30	20° - 42°	5,5	37	103.010	84	119,3	1
HMF 125 T4 (A6:3) F30	20° - 42°	7,5	45	120.810	84	126,6	1
HMF 125 T4 (A6:6) F30	20° - 42°	7,5	45	139.010	87	133,9	1

**6 POLE/ 6 polos**

Model	Angle	Min. Rat. power kW	Max. Rat. power kW	Air flow m <sup>3</sup> /h	Sound dB (A) **	Weight kg *	Connection diagram
HMF 45 T6 (A2:6) F300	20° - 45°	0,55	0,55	4.310	46	17	1
HMF 45 T6 (A2:9) F300	20° - 45°	0,55	0,55	4.540	46	17,5	1
HMF 50 T6 (A2:6) F300	20° - 45°	0,55	0,55	6.130	49	22,7	1
HMF 50 T6 (A2:9) F300	20° - 45°	0,55	0,55	6.550	49	23,2	1
HMF 56 T6 (A2:6) F300	20° - 45°	0,55	0,55	8.470	51	27,7	1
HMF 56 T6 (A2:9) F300	20° - 45°	0,55	0,55	8.970	51	28,2	1
HMF 63 T6 (A2:6) F300	20° - 45°	0,55	0,75	12.310	54	32,1	1
HMF 63 T6 (A2:9) F300	20° - 45°	0,55	0,75	13.310	54	32,6	1
HMF 71 T6 (A2:6) F300	20° - 45°	0,55	1,1	17.110	57	38	1
HMF 71 T6 (A2:9) F300	20° - 45°	0,55	1,1	18.610	59	38,6	1
HMF 80 T6 (A2:6) F300	20° - 45°	0,55	2,2	24.010	58	43,7	1
HMF 80 T6 (A2:9) F300	20° - 45°	0,55	2,2	25.710	64	44,4	1
HMF 90 T6 (A6:3) F300	20° - 42°	0,75	4	31.310	66	72,7	1
HMF 90 T6 (A6:6) F300	20° - 42°	0,75	4	35.810	67	78,1	1
HMF 100 T6 (A6:3) F300	20° - 42°	1,1	7,5	42.660	67	91,1	1
HMF 100 T6 (A6:6) F300	20° - 42°	1,1	7,5	49.910	71	97,2	1
HMF 112 T6 (A6:3) F300	20° - 42°	1,5	11	56.390	69	112,6	1
HMF 112 T6 (A6:6) F300	20° - 42°	1,5	11	66.810	74	119,3	1
HMF 125 T6 (A6:3) F300	20° - 42°	2,2	15	77.970	74	126,6	1
HMF 125 T6 (A6:6) F300	20° - 42°	2,2	15	89.910	78	133,9	1

**THREE PHASE RANGE 2 SPEEDS / serie trifásica 2 velocidades**
**4/6 POLE/ 4/6 polos**

Model	Angle	Min. Rat. power kW	Max. Rat. power kW	Air flow m <sup>3</sup> /h	Sound dB (A) **	Weight kg *	Connection diagram
HMF 50 T4/T6 (A2:6) F300	20° - 45°	0,55	1,1	9.460	59	22,7	2
HMF 50 T4/T6 (A2:9) F300	20° - 45°	0,55	1,1	10.110	59	23,2	2
HMF 56 T4/T6 (A2:6) F300	20° - 45°	0,55	2,2	13.100	61	27,7	2
HMF 56 T4/T6 (A2:9) F300	20° - 45°	0,55	2,2	13.810	61	28,2	2
HMF 63 T4/T6 (A2:6) F300	20° - 45°	0,55	2,2	19.010	63	32,1	2
HMF 63 T4/T6 (A2:9) F300	20° - 45°	0,55	2,2	20.610	63	32,6	2
HMF 71 T4/T6 (A2:6) F300	20° - 45°	0,55	3	26.410	66	38	2
HMF 71 T4/T6 (A2:9) F300	20° - 45°	0,55	3	28.710	68	38,6	2
HMF 80 T4/T6 (A2:6) F300	20° - 45°	1,1	6	37.010	68	43,7	2
HMF 80 T4/T6 (A2:9) F300	20° - 45°	1,1	6	39.610	73	44,4	2
HMF 90 T4/T6 (A6:3) F300	20° - 42°	1,7	14	48.350	76	72,7	2
HMF 90 T4/T6 (A6:6) F300	20° - 34°	1,7	14	46.410	77	78,1	2
HMF 100 T4/T6 (A6:3) F300	20° - 34°	4,5	20	58.310	75	91,1	2
HMF 100 T4/T6 (A6:6) F300	20° - 42°	4,5	20	77.010	81	97,2	2
HMF 112 T4/T6 (A6:3) F300	20° - 42°	4,5	40	86.990	79	112,6	2





Model	Angle	Min. Rat. power kW	Max. Rat. power kW	Air flow m <sup>3</sup> /h	Sound dB (A) **	Weight kg *	Connection diagram
HMF 112 T4/T6 (A6:6) F300	20° - 36°	4,5	40	88.910	81	119,3	2
HMF 125 T4/T6 (A6:3) F300	20° - 36°	4,5	40	108.010	83	126,6	2
HMF 125 T4/T6 (A6:6) F300	20° - 30°	4,5	40	101.010	87	133,9	2

**4/8 POLE / 4/8 polos**

Model	Angle	Min. Rat. power kW	Max. Rat. power kW	Air flow m <sup>3</sup> /h	Sound dB (A) **	Weight kg *	Connection diagram
HMF 45 T4/T8 (A2:6) F300	20° - 45°	0,6	0,8	6.640	55	17	3
HMF 45 T4/T8 (A2:9) F300	20° - 45°	0,6	0,8	7.000	55	17,5	3
HMF 50 T4/T8 (A2:6) F300	20° - 45°	0,6	1,2	9.460	59	22,7	3
HMF 50 T4/T8 (A2:9) F300	20° - 45°	0,6	1,2	10.110	59	23,2	3
HMF 56 T4/T8 (A2:6) F300	20° - 45°	0,6	2,2	13.100	61	27,7	3
HMF 56 T4/T8 (A2:9) F300	20° - 45°	0,6	2,2	13.810	61	28,2	3
HMF 63 T4/T8 (A2:6) F300	20° - 45°	0,6	2,8	19.010	63	32,1	3
HMF 63 T4/T8 (A2:9) F300	20° - 45°	0,6	2,8	20.610	63	32,6	3
HMF 71 T4/T8 (A2:6) F300	20° - 45°	0,8	3,8	26.410	66	38	3
HMF 71 T4/T8 (A2:9) F300	20° - 45°	0,8	3,8	28.710	68	38,6	3
HMF 80 T4/T8 (A2:6) F300	20° - 45°	1,2	7,5	37.010	68	43,7	3
HMF 80 T4/T8 (A2:9) F300	20° - 45°	1,2	7,5	39.610	73	44,4	3
HMF 90 T4/T8 (A6:3) F300	20° - 42°	2,8	14	48.350	76	72,7	3
HMF 90 T4/T8 (A6:6) F300	20° - 42°	2,8	14	55.210	77	78,1	3
HMF 100 T4/T8 (A6:3) F300	20° - 42°	3,8	28	65.950	77	91,1	3
HMF 100 T4/T8 (A6:6) F300	20° - 42°	3,8	28	77.010	81	97,2	3
HMF 112 T4/T8 (A6:3) F300	20° - 42°	3,8	44	86.990	79	112,6	3
HMF 112 T4/T8 (A6:6) F300	20° - 42°	3,8	44	103.010	84	119,3	3
HMF 125 T4/T8 (A6:3) F300	20° - 42°	5	44	120.810	84	126,6	3
HMF 125 T4/T8 (A6:6) F300	20° - 42°	5	44	139.010	87	133,9	3

\*\* Total sound pressure level at the point of maximum flow measured in dB(A) in the suction measured in free field at a distance of 6m from the source.

\*\* Nivel de presión sonora total en el punto de caudal máximo medido en dB(A) en la aspiración, medido en campo libre a una distancia de 6m de la fuente.

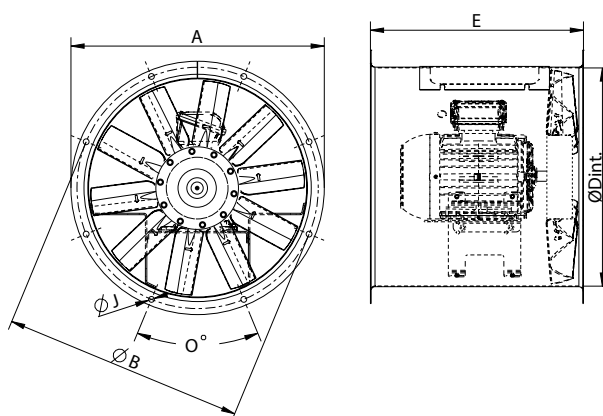
**DIMENSIONS / dimensiones**

model	ØA	ØB	ØD	E	Ø1	O
HMF 30M2-T2	374	355	305	350	10	8x45°
HMF 35	434	395	365	350	10	8x45°
HMF 35M2-T2	434	395	365	395	10	8x45°
HMF 40	472	450	403	440	10	8x45°
HMF 45	525	500	452	455	12	8x45°
HMF 50	600	560	504	440	12	12x30°
HMF 50M2-T2	600	560	504	540	12	12x30°
HMF 56	646	620	559	560	12	12x30°
HMF 63	725	690	633	550	12	12x30°
HMF 63M2-T2	725	690	633	770	12	12x30°
HMF 71	802	770	715	600	12	16x22,5°
HMF 71M2-T2	802	770	715	770	12	16x22,5°
HMF 80	892	860	801	600	12	16x22,5°
HMF 90	1000	970	903,5	820	12	16x22,5°
HMF 100	1115	1070	1013	820	12	16x22,5°
HMF 112	1234	1190	1132	1000	12	16x22,5°
HMF 125	1365	1320	1263	1000	15	20x18°



**CONNECTION DIAGRAMS / esquema de conexiones**

**1 THREE PHASE MOTORS 1 SPEED / motores trifásicos 1 velocidad**

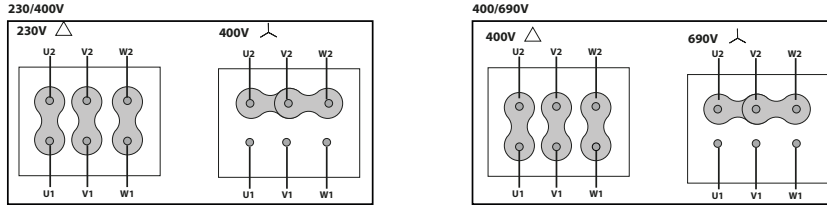

**2 2 SPEEDS / 2 velocidades 400V DAHLANDER (Y,YY)**

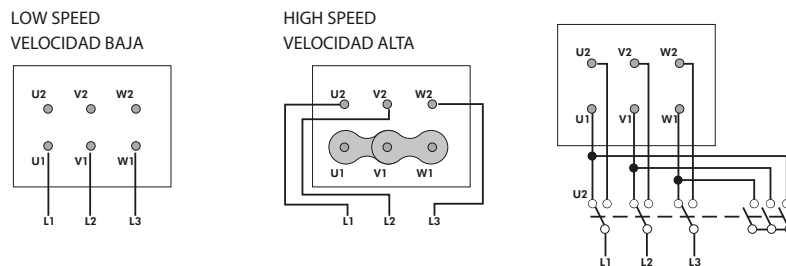

**CONSULT / consultar - HBF F300**

**CHARACTERISTIC CURVES / curvas características** pg.507